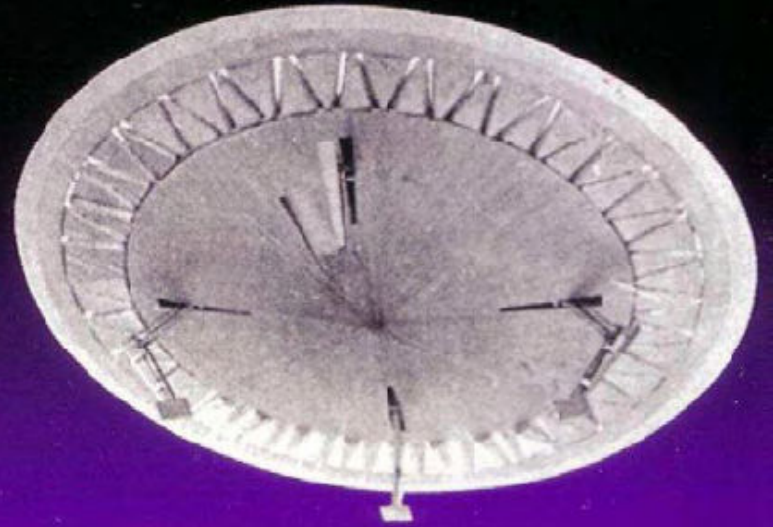
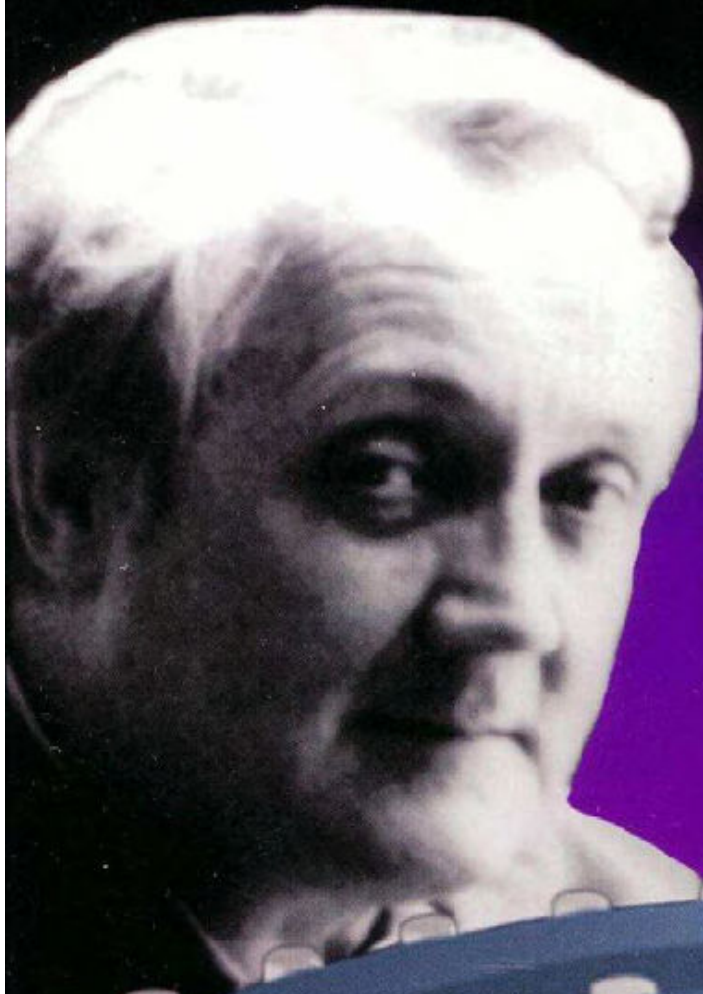
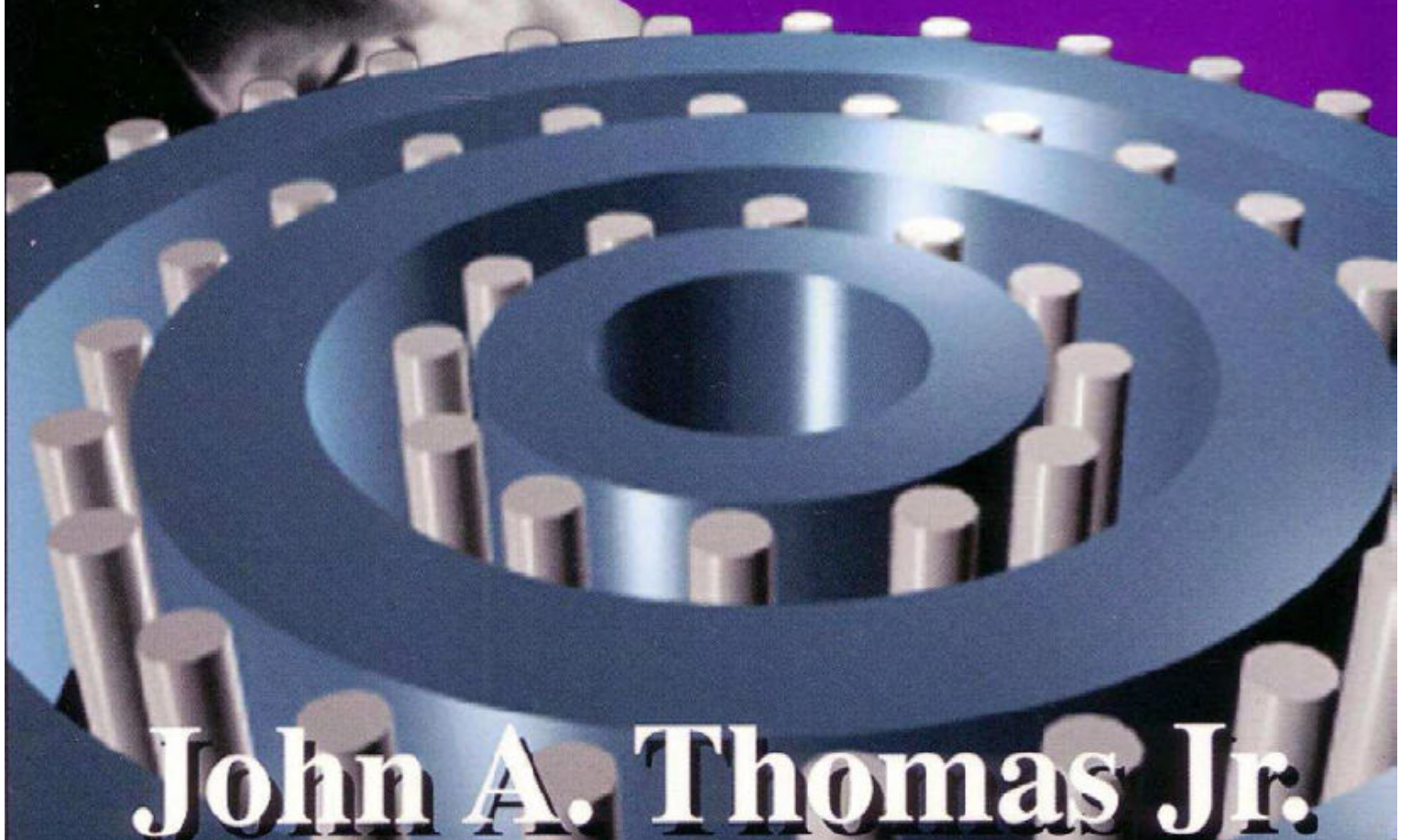


# ANTIGRAVITY: The Dream Made Reality



*The Story of  
John R. R. Searl*



**John A. Thomas Jr.**

## ABOUT THE TITLE

Prof. Searl has stated for the record that the title "Antigravity" is not technically correct. Although this term is used by the general public to describe a repulsion from the earth's gravity, scientific people will know that antigravity would be the opposite to gravity and would attract the earth's gravity instead of repelling it. The Inverse-G-Vehicle, using the Searl Effect Generator, creates it's own gravity field. This field is like the earth's field and because of this the two like fields repel each other. So instead of producing antigravity, the craft produces its own gravity.

**ANTIGRAVITY: THE DREAM MADE REALITY**  
**THE STORY OF JOHN R. R. SEARL**  
**BY: JOHN A. THOMAS, JR.**

This book contains information that was received by me from John R. R. Searl about his life and inventions. Searl has had an antigravity device since 1946. He also developed a generator of electricity that uses no input power as we know it.

There has been much written about Searl and his work but most of it is misinformation or guesswork. Many people have tried to duplicate his work but none have succeeded. All information in this book is correct and directly from the source, Prof. John R. R. Searl himself. This book is the story of a man who is trying to move the world into the future... and has been for years.

**Published By:**

John A. Thomas Jr.  
373 Rock Beach Rd.  
Rochester, New York  
14617-1316  
Phone: (716) 467-2694  
Fax: (716) 338-2663







**Prof. John R. R. Searl**

Author, Inventor, President, D.I.S.C., Inc.

Prof. Searl is the inventor of the Searl Effect Generator, S.E.G., which is its own prime mover and generator of electricity. He has written a series of books entitled "The Law of the Squares."

Prof. Searl looks at things differently from most people in that he equates everything to "The Law of the Squares." He is only interested in the Truth in all things. He has written his books to dispel all the misinformation and lies that have been written about him and his work. He is setting the record straight. These books tell of his life experiences as well as the technology that he has developed. After reading these books you may look at things differently.

He is currently the President and Consultant Engineer of the Direct International Science Consortium, Inc. (D.I.S.C.)

Prof. Searl is truly trying to bring us into a better future through this method of thinking and the technology that it has produced.



**John A. Thomas Jr.**

CEO of D.I.S.C., Inc.

Mr. Thomas has a technical background in electricity and process control. He has studied such varied topics as UFO's and Ancient Technology that has been lost or forgotten.

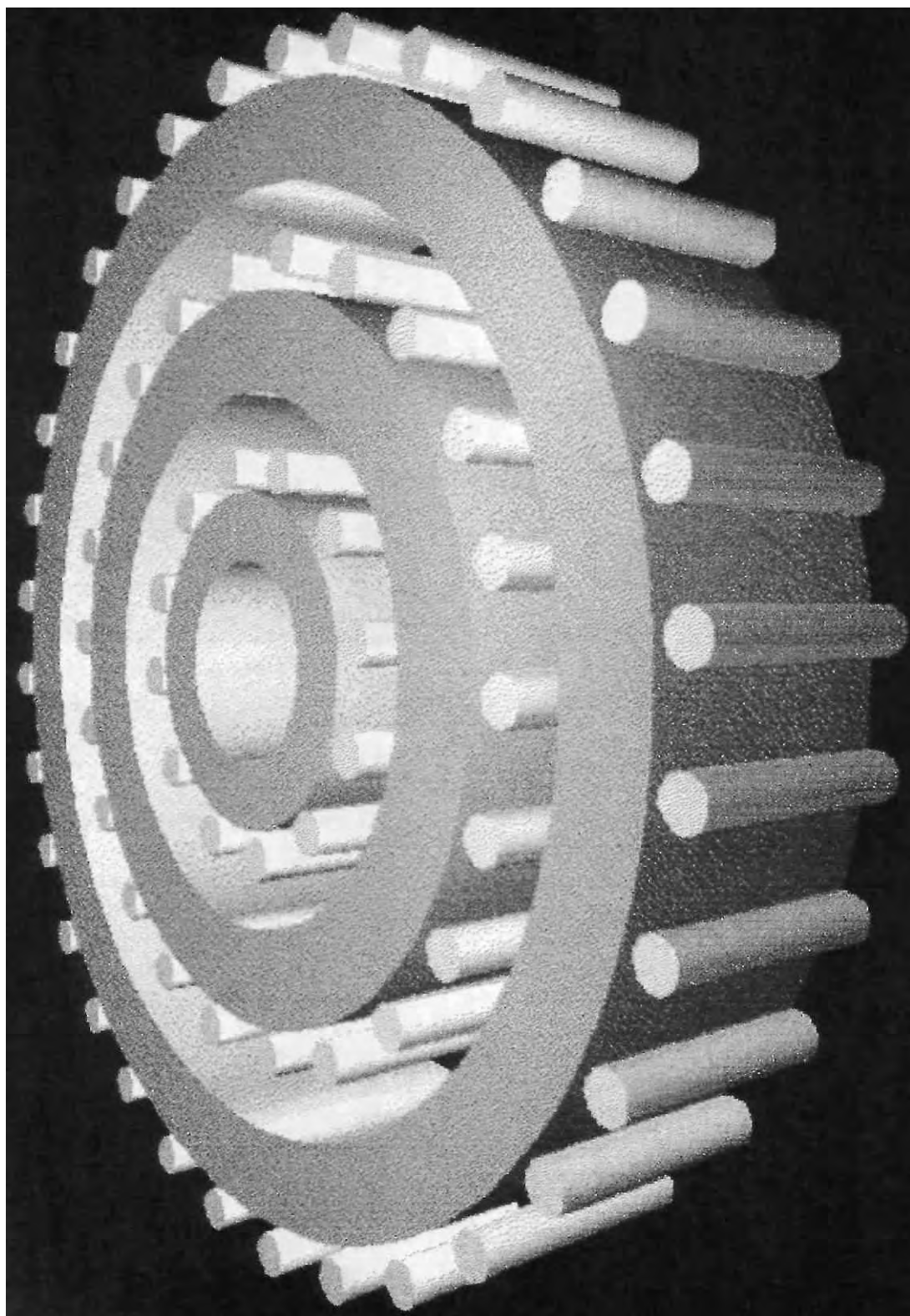
He has carried on the efforts of Mr. William Sherwood, formerly Professor Searl's contact and help mate in the National Space Research Consortium (NSRC).

He first contacted Professor Searl in 1990 and since that time has printed and distributed his books on "The Law of the Squares." Prof. Searl and John Thomas formed a company to build devices using this technology.

John has been a student of Professor Searl and has come to an understanding of "the square technology" which is the basis for the Searl Effect Generator (SEG) and the Inverse-G-Vehicle (IGV).

John is currently working with Prof. Searl to build a new prototype unit of the SEG.

John is presently CEO of the Direct International Science Consortium, Inc. (D.I.S.C.)



## **INDEX**

### **CHAPTER 1:**

Birth and Childhood  
First Dreams and How They Were Received  
First Jobs

### **CHAPTER 2:**

The Law of the Squares

### **CHAPTER 3:**

First SEG Made  
SEG's Made  
First Units That Went Airborne  
First Magnets Made  
Description of SEG Plates And Rollers  
SEG is a Prime Mover  
Description of Electron Action in SEG  
Searl's Flying Discs  
Inertia and Gravity Inside the Flying Craft  
What Makes the Inverse-G-Vehicle Fly?  
Application of Theory

### **CHAPTER 4:**

Photos, Articles and Television Coverage  
Demonstrations of the SEG  
The Searl Effect  
First SEG Electric Generator  
First Generator Trial  
Domestic Power Plant  
Flying Discs  
Starter Generator For P-11  
DEMO 1  
U.S. Demonstration of Flying Craft  
Flying Craft Size and Use  
Publicity  
Patent Taken Out  
Explosion  
Uses for the SEG

**CHAPTER 5:**

NSRSC

Arrest and Imprisonment

Court Battle

Life After Prison

Family Breakup

Thumped the Power Company & How SEG Works

Destruction of a Lifetimes Work

**CHAPTER 6:**

The Road Back

Meeting Susan

Starting Over on Research-date

Writing Books

**CHAPTER 7:**

The Future of Man

The Pole Shift

Meteorite Coming

Government & Big Business Blocking Progress

Do We Really Want Progress?

Prof. John R.R. Searl's Books



# **CHAPTER 1**

*This chapter will deal with John R.R. Searl's early days.*

John's mother, Violet Gertrude Maud Pearce, was born of poor parents on December 22nd, 1911 at number 8 Bridge Cottages, Shaw Road, Newbury in the county of Berkshire. Little is known of the origin of his father Robert Henry Searl as no record of his birth can be found. It seems that Violet and her parents had moved to a farm to work and that Robert had also moved in and worked on that farm. The farm was a poor one and the pay was so little and the conditions so poor that they became ill. The local council had to rehouse them at the council houses, Hampstead Norrays, then in Berkshire. But Violet's father, William Alexander Pearce then age 48, died from his illness which he had gotten from the farm job. This left Robert the only man in the house.

Robert was serving in India when Violet and he were married by proxy on April 26th, 1930. He served in India for 2 years and received 2000 rupees for bravery. Their son was born on May 2nd, 1932 at the Downs, Newbury Road, Wantage, then in the county of Berkshire, by the name of John Roy Robert Searl. John was born 1 month early and had black curly hair. The Downs at that time was a workhouse, a place of disgrace. It has since been torn down and it's believed that John was the last baby to be born there. Today the hospital part of the workhouse is used for a stable for horses. Robert brought a very heavy shawl back from India to wrap the baby in. One day John's mom and dad took him for a walk wrapped up in this shawl. Somewhere along that road, John slipped unnoticed from that shawl, and did a head landing on the road surface. They had walked for over an hour before Violet checked to see why the baby was so quiet. John was nowhere to be found. She quickly retraced her steps and found John still in the road. After that John suffered from "fits" and Violet was told by the doctor that if they didn't stop in 2 years he would die.

Their second child, Iris, was born at home on June 28th, 1934 while still at the council houses. The last child born to them was Peter. He was born at 214 Newtown Road, Newbury in Berkshire. They then moved to 86 Northbrook street, Newbury, Berkshire. Robert claimed that Peter was not his child and one Friday evening he just never came home. After she was abandoned, she could not support the children. As a result, she left the children with her mother and went to work on a farm. Now it came to pass that the milkman seeing 4 days milk on the doorstep called the police who broke in and found the 3 children in a bad way. Violet was sentenced to jail for 3 months for neglect. An order was granted for the custody of the 3 children at the Public Assistance Institution until such time as the N.S.P.C.C. will apply for permission before a Juvenile Court to provide them with proper care and attention. An investigation ensued and it was found that the children had been left alone and in filthy conditions often. Violet claimed that after her husband abandoned her she just lost hope. A warrant was issued for Robert but he was never found.

An order was made that the children be placed in Dr. Barnardo's Homes until their 18th birthday. John, at the time was 4 years old, and soon lost contact with his brother and sister after that. He was put into foster homes, and was frequently beaten in some of them.

One account as recalled by John: My foster mother was very religious and belted my bum daily. Maybe she thought that was where the brains are kept. The only good thing that came out of it was my bum could have won a prize for being so well developed and firm. For special, she made you take a hot bath for 15 minutes, then made you stand up to have your bum changed from a smooth surface to a red hot mass of blisters until there was no more room for another blister. His childhood was not pleasant one.

John had a series of dreams that started when he was 4 1/2 years old and ended when he was 10 years old. Something happened to opened his mind to the inspirational thinking that has followed him throughout his life. Perhaps it had something to do with his head injury as an infant. There have been cases recorded where an average person suddenly became a genius after sustaining a blow to the head. This may have caused the person to use more of the previously unused portion of his brain. Or the information could have been given to John from an unknown source. Or perhaps John is just an independent free thinker who does not accept things at their face value. John has stated that the technology that he has developed goes way beyond his knowledge and learning and that he has been inspired by some force to accomplish his task. He has used the dreams that were given to him to guide his way. When he comes to a point he cannot figure out he just goes to sleep at night and by morning he has the answer.

Everything in his life has directed him closer to his goal of saving mankind through the use of his marvelous technology. Things never seemed to come easy though. John knew that his dreams had some special meaning. The dreams started at age four and a half, but he didn't start to interpret these until he was 14. He had two dreams twice a year for six years. His description follows:

Dream 1: The mathematical aspect.

"I am playing a game of hop scotch...which of course is a set of eight squares...I find myself on square two, my pebble is on square three and I am in the act of going to hop over three into four, but I am instantly frozen with my right leg up in the air, and my left leg still firmly on the ground, via the foot of course.

#### KEY FACTS:

- 1....2 types of dreams, which are related.
- 2....There are always 8 squares.
- 3....I am always standing in square 2 and my feet are always in the same position.
- 4....My pebble is always on square 3.
- 5....There are 4 dreams a year.
- 6....There are 6 years of dreams.

In the first dream it is clear that I shall have something to do with very high energy levels of a solid structure, whose action is created by rotation. Because it is a solid structure it belongs to the third state of nature.

Nature operates here on earth in three prime states, which are:

1....GASES

2....LIQUIDS

3....SOLIDS

There is a 4th state in nature, but it is not available here on earth.

4....PLASMA

Thus in the dream its a pebble, a solid object, and being in square 3, which declares it as being an object of the third state of nature. Let's look at fact 1 and fact 3. There are 2 types of dreams, and I am always standing on square 2. Let us look again at my feet. The right is high to the left...translation...The right hand side is high in respect to the left hand side. It could mean that the right side can be classed as 1 while the left side can be classed a 0. Therefore, nature can only operate in two states, it can only be high or low. In plain talk, nature is binary in function, because I am about, or at least trying to hop over square 3, which is a function. Why can I not cross over square 3? It is clear that the game has been operating quite normal, until this point is reached. To understand this point better, I will now fill in a bit more detail about this dream. Up to this point, all the children who go to school with me are present and have been playing this game with me. But at this point they all instantly vanish from my sight. Now, at the same instant an object appears at the top end of the game, which should not be there, as it has no relationship to the game. The object took the form of the village steam roller...that being, a large roller being driven by a steam engine. Only in this case this object was many times larger than normal and is racing towards me. Therefore, I have only got a short time to save myself from being crushed to death.

So, we can state the reason why I cannot cross three is the fact that it is making an absolute statement as follows:

**STOP, THINK, ACT**

You may think that it is myself which is going to be crushed to death...in this case, you are wrong...re-cap again...at the instant in which I am frozen, all the children that I know have vanished...I am all alone. This means...that my generation will not produce any more generations of children to replace them...you automatically say

that they have produced them...I agree with you, but they will never draw their old age pension, or their children. In other words my generation is the end of the road unless we STOP, THINK, AND ACT.

In this troubled period I am all alone. Again in dream two I am all alone...WHY? Does this mean that I shall be the only person to be given the knowledge on what must be done to save all life? Does this mean that life as a whole has little chance to survive unless we prepare for the coming onslaught? Does history hold any past facts of such events...the answer is a positive, YES! Well developed groups have appeared on earth and vanished without a trace as to where they went. All we can conclude is that they were wiped out completely by a natural event. What dream one seems to state, is that

the human race will be wiped out by a pressure force many times greater than normal, crushing everything in its path, unless you act now to prevent it."

There is much more explanation given in Prof. Searl's books "THE LAW OF THE SQUARES". There are presently 5 in the series.

These dreams came to a four and a half year old boy. I am amazed that they could be remembered and interpreted in the way that Prof. Searl has done. I can't remember dreams clearly from the night before many times, although I have had dreams that I can remember. Prof. Searl's dreams must have been vivid and clear. They appear to have been prophetic and made a lasting impression on his mind. The message of the dreams has unfolded throughout Searl's life. Each experience he has had opens new doors through the better understanding of the message of the dreams. John has told me that everything that has happened in his life has seemed to have a reason and everything seems to be guiding him towards his goal. His knowledge of THE LAW OF THE SQUARES has given him an understanding of the workings of nature and science. Not the accepted science of the universities, although he has educated himself in many of them, but the science that is in harmony with nature. John works with nature instead of against it. John refused to accept things just because he was told that they were true. He had to see for himself. For this reason he has been at odds with "respectable" accepted beliefs taught by the establishment. Science has not always been correct in its assumptions or "Laws" but the scientists of the day always believed that their way was the only way to think. At one time scholars and scientists believed that the world was flat, then, that the earth was the center of the solar system, then, that there were only certain ways to generate power, accepted ways, etc.. For this reason he was labeled a trouble maker in his youth and was labeled a "quack" by the scientific community when he tried to bring his technology to the world. He has been fighting the insecurity and irate self-righteousness of the scientific and engineering community because he doesn't have the diplomas and structured training and education that they have. He is not a member of their "club".

*John's education as described by him...*

"My education is not good, agreed. I started at an infant school at Thorndon, where I learned absolutely nothing. Well that may be a little bit of a lie...I did learn what it was like to get your bum spanked by the teacher, which was much better than when my foster mother did it. Then I moved along to the secondary school at Eye. Here I again learned nothing, well except what the cane felt like in an effort to teach me not to take bombs apart and make fireworks out of them. I actually learned more from what they were trying to tell me not to do than what they were trying to tell me to do. Then I continued my education at Russell-Cotes Nautical school where I learned that all the things I had been taught were actually opposite and that the bum could be used for other things besides spanking. I received top marks for seamanship.

From there I covered a range of work training from rewiring of electric motors to dispensing doctors prescriptions, to medical training and nursing, including the caring for the elderly. Then onto electrical and electronic wiring and repairs, to the prototype wiring work for the atomic works and wiring of the VICTOR BOMBERS MK.11 and V.C.10's as a private contractor. To the wiring of the first fully transistor-

ized computer for the four large naval guns of NATO in Norway. I also covered the way to cut keys, fix locks, the building of T.V. and radio sets, and repair of them. I also covered everything about mechanical engineering from producing the machines from prints, to setup, to operating machines, to inspection of the finished product. This work also covered plating and treatment of various materials. Within this 40 years of practical experience, I undertook home courses on electronics 1,2,3 and 4 with B.I.E.E. plus 2 years on site training in radio communications at Reading University and 2 crash courses at the Open University, one of ROBOTICS FOR INDUSTRY and the other DIGITAL COMPUTERS FOR INDUSTRY. I have undertaken a flying training course to a higher standard than is normally required for private flying. I have experimented across a range of structures which the scientific man rejects as not possible, and proved them wrong. Those structures came from the LAW OF THE SQUARES. So to date, the best that I could achieve was a mere honorary degree of PROFESSOR of MATHEMATICAL STRUCTURES OF CREATION AND ENERGY. It's nothing much and not important...but at least it acknowledges my life's time work in the study of life and energy to research and development...making me the creator of a new TECHNOLOGY. The very first in this field of science. So I am sorry that I fail to meet your high standards of knowledge, but from my point of view, my knowledge serves all of my requirements to the fullest. I am pleased to state that I am learning something new every hour of my life.

Agreed, that my knowledge has not arrived from theory taught in schools. But it has been achieved by hard work in the practical field. At least I do have a very high practical experience which is worth it's weight in gold. Something that one needs to support ones theory. This puts me in a far better position to present my thesis upon a natural prime mover. You people of theory have not been able to put forward any real theory for such a prime mover. Your own statements upon this matter are a disgrace to your education. You may be good at spelling, grammar and english, but you are no bloody good at witnessing demonstrations of something which fails to conform to your knowledge.

I may not belong to your world of force to obtain results, and pollution, created through greed and destruction and hate. I belong to another world, which knows no hate, is not greedy, where all things in nature are appreciated and not destroyed. In your world you are causing nature to deteriorate and your square frame is now well and truly over loaded, and will soon collapse. For nature cannot forever continue to support your frame at the expense of other frames. Everything in nature has its' rights, and man is taking away the rights of other frames. Man's superior knowledge over all other creatures tends to make him greedy, with no care for other frames upon this earth, as long as he can make a quick buck, he doesn't care. There is nothing wrong in superior knowledge, if applied sincerely and honestly to better all mankind, including all creatures and plant life upon this planet. But alas, this is not the case. Far too often man's knowledge destroyed vast numbers of frames of other life forms, purely for gain or a kick. It appears to me, that education creates the very opposite of its objectives. Instead of producing products which can appreciate all of nature, it produces products for the destruction of nature. The one thing that man forgot is what I



have been telling him since 1946; man will destroy himself, through his own greed. So man will for certain reap the rewards he certainly deserves."

John has said that he belongs to a world that knows no hate. He has observed organized religions and saw hypocrites. People going to church every Sunday, and forgetting everything that their religion teaches as soon as they go out the front door of the church. John recalls a poem that he heard once as a very young child at the infants school...

This poem represents his attitude toward life...

Abou Ben Adhem (may his tribe increase)  
Awoke one night from a deep dream of peace,  
And saw, within the moonlight in his room,  
Making it rich, and like a lily in bloom,  
An angel writing in a book of gold:  
Exceeding peace had made Ben Adhem bold,  
And to the presence in the room he said,  
"What writest thou?" - The vision raised its head,  
And with a look made of all sweet accord,  
Answered, "The names of those who love the Lord."  
"And is mine one?" said Abou. "Nay, not so."  
Replied the angel. Abou spoke more low,  
But cheerily still; and said, "I pray thee, then,  
Write me as one that loves his fellow men."  
The angel wrote, and vanished. The next night  
It came again with a great wakening light,  
And showed the names whom love of God had blest,  
And lo! Ben Adhem's name led all the rest.

It is John's belief that he may very well be the only man in the world able to save all mankind, but that will be explained later in this book.

# CHAPTER 2

This chapter will deal with Prof. John R. R. Searl's LAW OF THE SQUARES. This is the basis for all the technology that has been developed by Prof. Searl. This has come to him through his dreams and his study to interpret them through the years. John has said in his lecture of 1986 in Munich, Germany that the law of the squares is really a very old technology. He states that when the Bible was edited by the church, that many books were not included. One man had written 144 books of which only a few survived and those were omitted also because they were not understood or accepted by the church of the time. These books contained information based on The Law of the Squares.

The squares are a numerical representation of matter and energy. There are three groups of squares and three only. They are:

GROUP 1 - ROTATE - All odd numbers belong to this group. That means half of all numbers are a group one class.

GROUP 2 - OSCILLATE -All even numbers that divide exactly by 4. That means half of all even numbers belong to this group.

GROUP 3 - OSCILLATE EXCEPT FOR THE CENTER CROSS WHICH ROTATES - Half of all even numbers belong to this group. All even numbers that do not divide exactly by 4.

There are numbers which nature does not use in its building blocks. These have been listed in "THE LAW OF THE SQUARES- BOOK 1"

The simplest GROUP 1 square that can be shown is a square 3. This consists of a block of three by three numbered squares. It is level 1 and includes 0 as its first number. The squares are shown in their original uniform layout and are numbered from top left down in columns from left to right (See Fig.1). If you add across any line of numbers you will get a random sum or output.

This block of numbered squares can be arranged so that all the rows of numbers, vertical, horizontal, and diagonal will add up to the same number. This square is called a RANDOM square because the position of the numbers appear random but the output is uniform, where in the original UNIFORM square the position of the numbers are uniform but the output appears random. In a random square 3, level 1, the sum of any row is 12. 12 is the smallest number for a smooth operation of an electric current. This is shown in the linear motor which uses 12 phases for its drive unit. Since we never use 0 in our work we shall start this square and all subsequent squares with Level 2, which starts with the lowest number of 1. All GROUP 1 squares have a single central square and they are made up of an odd number of squares. Thus they would be 3,5,7,9,11 etc.. If you take many of the same RANDOM squares and place them side by side you will see a pattern that continuously repeats itself throughout the matrix. GROUP 1's rotate.

**GROUP 1 SQUARE LEVEL 1:**

<b>0</b>	<b>3</b>	<b>6</b>
<b>1</b>	<b>4</b>	<b>7</b>
<b>2</b>	<b>5</b>	<b>8</b>

UNIFORM

<b>7</b>	<b>0</b>	<b>5</b>
<b>2</b>	<b>4</b>	<b>6</b>
<b>3</b>	<b>8</b>	<b>1</b>

RANDOM

**GROUP 1 SQUARES LEVEL 2:**

<b>1</b>	<b>4</b>	<b>7</b>
<b>2</b>	<b>5</b>	<b>8</b>
<b>3</b>	<b>6</b>	<b>9</b>

UNIFORM

<b>8</b>	<b>1</b>	<b>6</b>
<b>3</b>	<b>5</b>	<b>7</b>
<b>4</b>	<b>9</b>	<b>2</b>

RANDOM

Fig.1

1. The line value can be predetermined by adding the numbers of the square up on the diagonal from the top left to the bottom right.
2. The center number of a GROUP 1 is equal to the line value divided by the square size. Therefore, the center number of a square 3 level 2 would be, 15 divided by 3 or 5.
3. Square 3 consists of 2 squares. The center single number being the first square and the next square out or 2nd square consisting of the 8 numbers that surround the center square. The total of the 2nd square can be obtained by multiplying the center square by 8, which is the number of numbers that surrounds the center square. Thus, the total value of the 2nd square out is 40.
4. There are 8 different ways you can add different lines to get the line value. They are 3 vertical, 3 horizontal and 2 diagonal. These are called options. Thus, square 3 has 8 options.
5. The total of all the squares in a square is equal to the line value times the square number. Therefore square 3, level 2 total would be 15 times 3 or 45.

6. The four corner total is equal to the center square times 4. As the squares get larger there are additional rules involved but there are always numerical links between the parts of the square. With a little practice you can learn the pattern of numbers and then do all group 1 squares by yourself. Prof. Searl has shown up to square 25 in book 2 of THE LAW OF THE SQUARES. He has figured the squares to over square **100**.

### GROUP 2 SQUARES:

1	5	9	13
2	6	10	14
3	7	11	15
4	8	12	16

UNIFORM

1	12	8	13
15	6	10	3
14	7	11	2
4	9	5	16

RANDOM

Fig. 2

1. Group 2 squares are always even numbered squares, but not all even numbered squares are Group 2. Some are Group 3 squares.

2. Group 2 squares oscillate instead of rotating.

3. If you look at a Group 2 square in the Random state you will see that the numbers switch positions throughout the square. This switching shows the oscillation of the energy patterns within the square or between atoms. The square is a numerical representation of the interaction between different atoms within a structured mass.

4. There is a center block of 4 separate squares. This is called the kernel square. Notice that all Group 2 and Group 3 squares have a kernel square. John Searl's dream 1 states that when you are looking at a square, you are looking at 2 frames no matter what square you are looking at. (That squares are made from squares.) But the dream states more than that - it states that these 2 frames are at right angles to each other and held apart by 2 cross beams. So there are 2 prime states and a secondary state. So 3 conditions are present in a square.

## Chapter 2

The three frames of all kernels are:

- 1....SPACE FRAME
- 2....TIME FRAME
- 3....ENERGY FRAME

Let's look at the kernel square of a uniform square 4:

6	10
7	11

Now we examine the properties of this square:

- 1...VERTICAL- left  $6+7=13$  and right  $10+11=21$ . Then subtract 13 from 21 to get a directional force of 8 to the left.
- 2...HORIZONTAL- top  $6+10=16$  and bottom  $7+11=18$ . Then subtract 16 from 18 to get a directional force of 2 upwards.
- 3...DIAGONAL- top left to bottom right  $6+11=17$  and top right to bottom left  $10+7=17$ . Then subtract 17 from 17 and get 0 showing that the square's energy is conserved.

There is no gain or loss thus this kernel is in harmony. From dream 1 Searl states: "We will have a lifting force of a value of 2 and a pushing or pulling force equal to the last value of the second column of the uniform square. We see that this holds true. We also see that the right hand vertical is more positive than the left hand vertical and the horizontal lower is more positive than their upper horizontal."

In Prof. Searl's book 1A he explains this in detail and also shows further switching of numbers to increase the thrust and lift of the square without changing the basic properties that keep the square in tune with nature. In John's words, "If a building block conforms to a mathematical kernel and its energy frame is conserved, and that kernel contains 4 different forces conforming to the requirements above, then if a similar piece of material is placed upon that material, it will experience a lifting force and a pushing/pulling force... For that is the LAW OF THE SQUARES."

### GROUP 3 SQUARES:

This square has the properties of both the Group 1 and Group 2 squares as it both oscillates and rotates. There is a central cross which rotates in the Group 3 squares. The remaining squares oscillate. Group 3 squares are used to make flying machines as they put out a great amount of power.

The central cross is made up of the 2 vertical center rows and the 2 horizontal center rows of the square. The first Group 3 square is a square 6.



SQUARE 6 LEVEL 2:

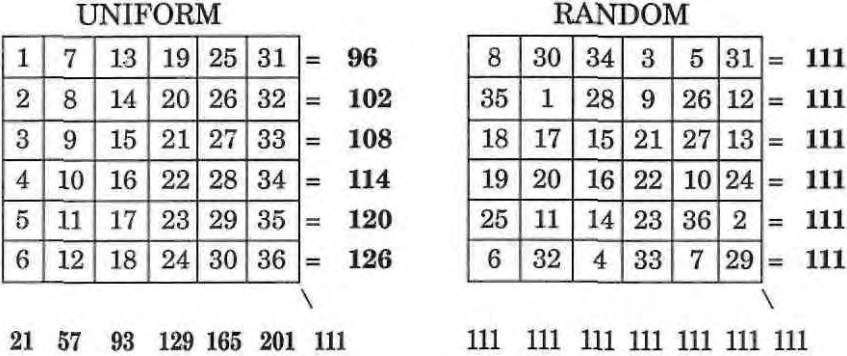


Fig. 3

Group 3 squares are the most complicated squares to do and explain. As you study the square you will see that there is a rotating action of the center cross and the same oscillating action as a Group 2 in the remaining 4 corners. You will have to do a little work to see it, but be persistent, you can do it.

The Random squares shown here are not the only answers to correcting a square to the Random state. Here are a few squares for you to compare.

SQUARE 4 LEVEL 2:

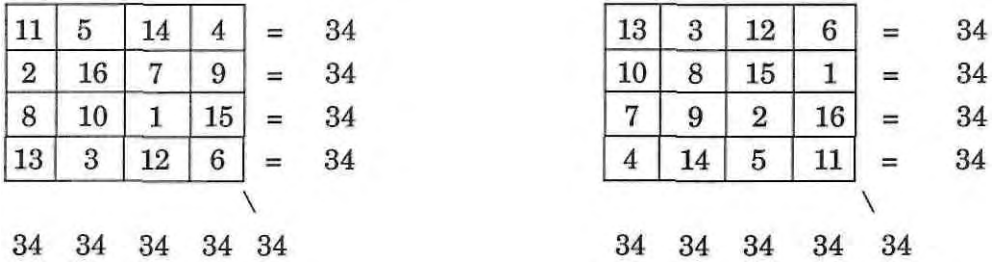


Fig. 4

The squares can be solved in many ways but only one way works the best in the construction of an energy producing device. John Searl developed his first SEARL EFFECT GENERATOR (SEG) back in 1946 at the age of 15.

The law of nature states that no TWO BODIES or PARTICLES can share the same SPACE FRAME within the same TIME FRAME. But the law of nature does state that TWO BODIES or PARTICLES CAN SHARE THE SAME SPACE FRAME at different TIME FRAMES. However, TWO OBJECTS cannot share the same TIME FRAME within the same SPACE FRAME. Thus, TWO OBJECTS can share the same TIME FRAME provided they occupy different SPACE FRAMES. These statements can be seen while studying the Law of the Squares.

Some other interesting facts:

There are TWO PRIME STATES within nature: **ENERGY AND MATTER**

Energy and matter are reversible. Energy can switch to matter and matter can switch to energy.

Nature operates upon TWO PRIME STATES: LOW ..... 0 ..... NO ..... RED  
HIGH ..... 1 ..... YES ..... GREEN

This simple rule of Nature is used by us in many ways, but within Nature it's used all the time. Therefore, Nature tends to be BINARY within its actions.

Nature sometimes makes a triangle agreement with its actions of functions: one input and two outputs or two inputs and one output. In the first case it's an inverted Y, it is not a mirror image. In the second case it is the original Y. We can see that Nature builds blocks which can be used either original, mirror or inverted.

In matter there are THREE PRIME STATES, which are: GAS, LIQUID AND SOLID. Within solids we have three states which are Conductors, Semiconductors and Nonconductors. The elements are the building blocks of Nature. Here again we can break them down to Nonmetals, Light Metals and Heavy Metals. In designing, many points have to be accounted for. That applies to Searl as well, as he wants to work with Nature and not against Nature.

All matter and all life conforms to THE LAW OF THE SQUARES. These are nature's building blocks from the smallest particle to the largest universe. All energy exchange can be explained using this law. From chemical bonding to the production of natural energy.

"Modern man" has perverted the laws of nature and has only limited knowledge of how nature works and how man can work with nature, rather than destroy its beauty and balance.

Searl's Law of the Squares is the basis for an energy producing generator that works with nature and will not consume or harm any part of nature. Indeed it will help nature heal the earth from the damage that mankind has caused.

The Law of the Squares is explained in detail in a series of books written by Prof. John R. R. Searl. They are titled:

**"THE LAW OF THE SQUARES"  
(Book 1,1A, 1B, 2, 3, 4, 5, 6, 7, 7A, 7B, 8, 8A, 8B...)**

These books have been written from 1990 to 1999 and are available through:

John A. Thomas, Jr.  
373 Rock Beach Road  
Rochester, New York  
14617-1316  
Phone: 716-467-2694  
Fax: 716-338-2663

In these books is the key to a new technology and how to put it to use. This information has never been allowed out to the public in the past. Everything in the books is the TRUTH and there is no misinformation in them. They are copies of original manuscripts made by Prof. Searl and have not been changed or edited in any way. Through these books you will get to know the inventor as well as his technology. In Searl's words "You have to know the inventor in order to understand the invention." This book could be termed as a primer to Searl's books on the Law of the Squares as much of it has been taken from the original books.

In his book 2 he has shown up to square 25 and given the Go - No Go tables up to 8774. These tables and squares can be found nowhere else. Many properties and symmetries are given throughout the books. When you see and understand these you will be able to work out the squares for yourself without having to look at the books. The squares are the key to the SEG (Searl Effect Generator).

All the information needed can be taken from the square used for the work. This includes all sizes and dimensions as well as amounts of different elements used. The SEG is in perfect harmony with the squares and nature. It must be made correctly and it will only operate as a completed unit. Someone once broke one of the magnetic rollers to see what it was made of. In doing so he ruined it and the operation of the Searl Effect. The SEG works because of the exactness of ALL its components, in proportional content and dimensional size and exact frequencies used. These are all taken from the squares. Once completed, the SEG operates like a huge laser diode, a solid state device which starts at the atomic valance level and ends with an output of energy, both electric and magnetic, and in the flying craft it is also gravitational energy.

# **CHAPTER 3**

*This chapter will deal with Prof. Searl's early days and his first experiments with his SEG (Searl Effect Generator).*

John was placed in a foster home when he was still very young. He was a very curious boy and wanted to know how everything that he saw worked and was eager to learn and understand everything he could. I asked John to describe his young days of work starting at age 14. Here is his telling of his early years.

John Searl (J.S.) - I started in electrical rewinding of motors. Stripping motors and rewiring them. Winding coils. I was actually starting a five year apprenticeship. But weeks later I left that and went into pharmacy. Learning to dispense doctor's prescriptions. And that of course REALLY was a key. Because in the time I was in the electrical trade I found out how electrical motors worked. What caused them to work, how they were wired, how to wind the coils, how to insulate them and so on. So I picked up very quick a key thing but you see I couldn't stay there. Because if I stayed there I'd be locked onto one narrow band. I had to go on to the medicine field to learn how chemicals are mixed together to produce certain results. And then from there I went on to medical training. All these changes occurred within a short time frame.

I was told by my boss at the chemist's shop that I was certainly qualified for something far better, having far more skills than what was required of me. He said he was holding me back. So he wrote a doctor to get me to see him, and he did. And he said, "Yes, I'll put you on the ward for a months trial," to see how I'd get on. So I went on the ward for a month and did so well that he put me in the lab for a month to see how I got along there. I did so well there that they wanted to pay for six years training at Oxford University. And when I left there I would be a brain surgeon. But my guardian stepped in and stopped my training. They put me down to an old people's rest home. There was about 45 old age women, bedridden. And the job was to help the night nurse on nights. Of course I learned a lot. I learned about old age and what problems came along and started questioning these problems. Now while at the hospital training, I learned a lot because I came in contact with the brain, kidneys, liver, heart, unborn babies and more. So I questioned my instructors very strongly about things. In fact I wrote an essay and they downed it. And it turned out a few years ago that I was right! They were wrong.

John Thomas (J.T.) - That was at the old age home?

J.S.- Yes. Now I doctored myself. I went down with the flu, a bronchitis flu, and I went and wrote a prescription and got the medicine and got back. And one day the matron went into my room to see if I was keeping it clean and tidy and saw this bottle of medicine and saw what it was. She came to me and asked how did I get it. I said, "I got it." She said, "You have no right to any medicine unless my doctor here says you can have it. This is poison and you shouldn't have it." So they called up the Homes, which were my guardians. They came running down and took me to the chemist's shop. The chemist got the prescription out. He said, "The prescription is right. Absolutely cor-

rect. I dished it out as stated and there was nothing wrong with the prescription and therefore as far as I'm concerned he was the authorized person to pick it up and I gave it to him. So I have not committed any crime."

So they whipped me off to London. I got fed up with sitting about so I went to the cinema to see a film. I was so impressed with it because I had just seen a film for the first time. I wanted to know how motion was done on film. So I went to the manager and asked him how do you do this? So he said, "Would you like to see how it's done?" So he took me up to the projection room and got the chief projectionist to show me about. And when he opened the arc lamp door he said, "You see the thin rod, carbon rod, and the thick one. The thick one is positive and the thin one is negative. And you see that the positive one has got a hole, a crater and the negative has got a point." He said, "The power comes from the positive and goes to the negative." And I said, "You're wrong. It goes from negative to positive." He said, "No, I've been in the theater a long time. It goes from positive to negative." So I said, "If it goes from positive to negative as you've said and not from negative to positive, how do you explain the crater in the positive? You've got a crater there because something is hitting it hard. It is knocking the stuff out. And it has a point on the other end because stuff is leaving it from the outside to the inside and it splits away." So when the boss saw how I was tearing his top man to pieces, and I'm only a kid, he asked me if I wanted a job! So I was given a job right away.

But within a couple of months a new law came out that people under 16 couldn't be in a cinema where X films are being shown. So that meant that he couldn't employ me on those weeks when they were shown. So he said to me that there was a cinema at Illford which was S class. They have two floor levels operating and they only show an X film on one floor. So when they show an X film they can always send you up to the next floor. It's got the latest equipment and that should really fascinate you.

Of course when I got there, the chap in charge, the chief projectionist, was also a ham operator! He felt sad for me because I was just an orphan. So he took me home and introduced me to his family and showed me all his ham equipment and told me about the things you have to do to become a ham operator, and he started teaching me. We got on very well and things started changing. They had a party at the cinema and wanted me to join them after the show to celebrate. And so I asked the Homes permission to stay late. They said, "You have to be back by 11." and well, we had hardly started the party after the show. So what happened was I stayed overnight. I went to sleep on one of the big couches in the lounge. And some of the usherettes slept on the couch as well. The couches were massive. You could get 4 or 5 of us on one of them. And they just threw curtains over us to keep us warm. And of course when I got back the next day they went mad, The Homes did. Stopped me from working there and things started going all wrong.

But as I look back on it today, I can see the picture now, when I look back. I was getting into a permanent fix and I musn't. I need a lot of experience across a wide field to do what I've got to do. I not only had to know what happened to people, I want to understand how they work, how they function, why this, why that. About materials, how you can do, what you can do, what part of materials will do this and how it functions.



So by the time I was about 30 I really knew everything about the atom. What you could do with it and what you can't do with it. I began to realize that a certain law applied. And that law was the SQUARES. These squares define everything. What you can and cannot do in nature.

J.T.- It sounds like you've had quite an experience John.

J.S.- Oh I had to go through a lot. I even had to take up flying. I hit a problem there when we were getting going. Every pilot that came to answer my advertisement (to test fly the Levity Disc), when they came to see the model tested, they said, "Oh, I wouldn't take that up! It turns too fast. Too sharp! You'll get killed!" So the question was no financier would back a project which wouldn't get off the ground. So I had to do something about it. I had to licence myself for flying. So that I could fly it. The trouble was it had to be more than just a private licence. So I had to buckle down and really get up to a commercial standard so that I'd be able to test fly it myself. And that's what I did. I hammered it, and hammered it and got the standard required.

J.T.- You never did get to test fly it though did you?

J.S.- No, We got the land ready to build a three seater and then the check promised was stopped by the Prime Minister of New Zealand. It was in the paper. We have the paper cutting. "John will have to find his money elsewhere. The prime minister has stopped the check and told the people to invest the money in marsh gas."

J.T.- Oh well.

J.S.- So the check didn't come. So we had to forget it. We did work hard. We got everything ready to go ahead. We had to move trees. We had to move debris. We had to level the ground off for the building of this three manned craft. As far as I was concerned, we brought in heavy tackle equipment from miles away and it cost quite a packet to get it in and do the job and get it back again. But we couldn't build it. That was the trouble. It was a sad thing. But of course I always get kicked in the pants about it. Everybody said, 'You said you were going to build this three manned craft and you didn't!'

J.T.- Well what are you going to do without money?

J.S.- The point is that they don't look at it in the proper light. They said, "You said you were going to do this." I said that I'd do it if we had the money. If I'd had the money, I wouldn't have been asking for the money. But the thing is, today, things are moving slow. But I find that if I try to push people, I lose everything. They stop because they can't keep up with the pace. And I sit back here fiddling with my fingers, but annoyed about it myself. I'm annoyed that I'm not racing as I was years back. And time's running out.

John had many jobs and experiences as you can see, and what does he mean by "Time's running out"? This will be explained later in the book. I was curious as to when he first started building his first SEARL EFFECT GENERATOR. In his books he had this technology since 1946. So I asked him to tell about his first units. This is his reply.

J.T.- You said that you were just 15 years old when you made your first SEG?

J.S.- Yes, well when we say the first one, it's an object which shot off the table when we started it up. It bashed up against the wall. The sparks flew everywhere, but that was the beginning. I destroyed the house with it eventually. When we tried to make them a little bit bigger, it just shot through the ceiling! The ceiling came all down and it tore through the roof which fell in. We had to move because there was so much damage that the house was unfit to live in!

J.T.- That must have made a big hit with everybody!

J.S.- Yes! It did! Well there were a little later ones, much bigger, we put up and they got shot at by an RAF (Royal Air Force) chap that said I was frightening his pigeons.

J.T.- Oh, really! He shot at it?

J.S.-Yes! He shot at ME!!

J.T.- Oh no.

J.S.- Yeah, there were bullet holes in the building. A bullet shot past me.

J.T.- That was kinda scary!

J.S.-Yes. Oh, we had plenty of fun. I should write everything down that happened. It's shocking that I'm still alive today.

J.T.- What building were you living in then?

J.S.- We had a shed. The old man who took me in was dying of cancer. The hospital gave him about 6 to 8 weeks to live, so he begged to go home. So they brought him home and his wife thought it would be nice to have a lodger to help out. And back then I was lucky enough to want an accommodation.

I arrived in the area so they took me in. And when I told him about the things I had in my mind, he said "John if you can make people look up in the sky, that would be a great achievement because everyone who walks around here, walks with their head down, looking at the ground," Well I said, " That should be no problem." But I said that I would need a shed and materials. He called his son up and said, "George, take John down to the market and get everything he wants." And things

really got going and we started building 6 footers and 8 footers and 12 footers. But then we really got down to the job of discovering that there was no way of stopping these things from going up! Of course we eventually did learn, but my word, it took some effort!

J.T.- So you went down to buy all this stuff. You bought all the chemicals?

J.S.- Yes, he paid for everything.

J.T.- So the first one that actually took off, that actually left the ground, was a magnetic motor.

J.S.- Yes. They were all magnetic motors. The trouble was, they weren't intended to fly! That was the bug!

J.T.- Yes, I imagine that was quite a surprise!!

J.S.- Yes that was a surprise package. There were good people who were so excited by it, they paid for more to be done. And slowly we broke out the problems step by step. If it hadn't been for those good people, well I would have had to give up then because I couldn't afford to carry on - throwing money up in the sky and losing it.

*I asked John to describe what happened when the first units went airborne.*

### **FIRST UNITS THAT WENT AIRBORNE**

J.S.- Well you can't control the little things at all. All that happens is that once they get the speed up to get to the superconductor stage, it lifts. And it lifts to a given height. It's hard to determine just how high that is. It's higher than the buildings around and higher than the trees that were around there. And then there's what we call a "rest section", where they seem to rest. And then suddenly they get very bright. The glow gets brighter and brighter and brighter. It's obviously getting very superconductive. There is an immense plasma building up all around it. Then electrical appliances switch on. Televisions and radios turn on by themselves. This happens all around as the power leaks down cables and aerials and things like that. And suddenly it shoots off. It just goes off, up and up and up, until it's lost. You can't see the light glow or anything anymore. So we have to assume that they have gone right out into space.

J.T.- And that will go automatically with no load coils or anything.

J.S.- Yes, it will just go on and on until it balances out with the forces of the planet. And then it will orbit. So we don't know where the bits have gone to. Someday, who knows, somebody may find them!

J.T.- That would be quite a find!

J.S.- Yes, Well of course after we'd done six of them, the old boy who paid the bills died. So work literally stopped for awhile. So then I formed a party of old retired people who had money, and we started looking at the problem of building the body. Working on the body shape, trying to work out ideas on how we could control this. And then we did. We were successful in the end, because a lot of things happened while I was experimenting. I found out how it cools an iron down which was red hot, and it would turn icy cold. So we learned bit by bit, by sheer experimentation, chance you could say. Then again most of the big experiments were just chances that the inventor hit upon. They were probably looking for something different! And then hit on this and said, "Oh, that's interesting!" And then developed it. And that is really what sort of happened in my case. It was just sheer luck that while you were trying something, something else happened. And that gradually let you build up the picture of what was going on!

Once we understood what was going on, then it was easier to try to put together a structure that would allow you to make use of it. I agree, at the time, we could not see how to use it as a domestic power plant. We could see it as a flying machine. And that is what we worked on. But once we mastered the holding of it and we could hold it at low heights and keep it there stationary against all winds. Then you see I was winning! But the thing was, we couldn't stop the motor!

We were never able to stop that until I was lecturing in Canada. And it was on the TV program that I was doing, that the camera came forward, and for the first time ever, the rollers stopped. And I was quite embarrassed. And yet it was the greatest miracle of the lot. Because when they pulled back to show my face, the thing started off again. And then I knew instantly what I had to do. The frequency of the camera was the key to stopping it.

## FIRST MAGNETS MADE

**J.T.-** When you made your first magnets, how did you press them?

**J.S.-** Well we were very lucky. It was a big built up industrial area. There had been ammunition and tanks and bombs and shells. So for pressing we were lucky because the pressing was not like they do it today but how they used to do it in my young days. So there was everything basically available. All we had to do was find a magnetizer that we required. And that is what the Electric Board had. A magnetizer standing idle.

**J.T.-** Wow, you're kidding!

**J.S.-** And I asked if we could have the head modified. And they said, "You can take it if you want it!" But I said, "I got nowhere to put it!" But I said, "If you can keep it in the back shed there and I can have the right of using it, that would be ideal!" So that's what happened. They hadn't heard from me for about 8 years, so they got rid of it.

**J.T.-** Oh dear.

**J.S.-** When I eventually went and dropped in on them a few years ago, they told me, "I'm sorry, we did try to find you to ask you if you wanted it, you could take it. But as we couldn't find you we in the end had to dump it."

**J.T.-** Oh...And that's the one you had modified with the A.C. windings?

**J.S.-** Yes, yes. Because what we do is not what magnetizing companies want. We do something entirely different and it's a different surface that we're magnetizing compared to what is commonly magnetized.

**J.T.-** What did you use to press the magnets?

**J.S.-** We had hydraulic presses. Hand presses. And pressed them. We had no trouble in getting it right. Like in our present work. I asked John to explain what the action was in an SEG. His answer follows:

**J.S.-** There are lots of ways of making mechanical effects to demonstrate. In one of the films we have here we show a very simple way which shows a ball running along the wave trough, to and fro. All that's happening is there are bars just going up and down. You're converting a vertical motion into a rolling result. You're making a ball roll freely by the action. And it was things like this, when I was 14, that made me realize that the whole thing about free energy is right there! All the planets work on it and will always work on it. It's simply building up lines of force and sitting in it. And as the forces move, so you're propelled along at right angles to the action. And you're made to

spin. The force is forcing you to spin. And if this force is slightly out of unity, the more it's out, the faster you'll go. The greater the slip the faster you'll move.

And when I realized this, I had looked at lots of things in industry. The single phased motor, the three phased motor, and then how you come to work a walky-talky of the second world war. That fascinated me. But when I saw that we are dealing with phases and frequency...these are key things. It wasn't so important...the magnetic thing. It was important to get this frequency and phases right. And there must be a slip to cause motion to take place.

What is happening in my case is the axis of the roller rotates. So the roller rotates in itself. In its own right and then it rotates around the plate because the force of the plate is acting on the rollers force. There's a slip. And high energy builds up from that slip and makes it move. And because there is no point of balance on that surface it will continue forever as a straight line.

When you use a straight bar system, you do have two ends of the bar and that presents a little bit of a problem. But even that, I solved. The roller would jump to the end which is a permanent monopole, D.C., yet it jumped across that without any signs that there was anything there! And then carried on along the other side and jumped through the bottom end and back.

*On another occasion John described the workings of the SEG (SEARL EFFECT GENERATOR)...his reply follows:*

J.S.- Well what you've got is all north on one side and all south on the other, but the south one is off course, it's out of step with the north so they lay diagonal across the bar. So you've got a wave. When the roller operates, you've got a north pole lining up with a south pole but the south pole is not lining up the north pole. It's between 2 south poles.

J.T.- So its twisted.

J.S.- Yes. The field is twisted. The field on the rollers is twisted. You've got 2 fields at right angles to each other and because there's a slip between these 2 fields a force is generated on the roller so the roller moves. No input is needed to cause rotation. And because you've got magnetic flux available in rotation, that means you have a moving flux field. And if you've got a winding you must have electricity. You've got no other choice.

J.T.-I was under the miss-impression that your first unit was some sort of segmented disc.

J.S.- Ya, I don't know who started that rumor but what they really mean by that is that the rollers are running around and they appear just like a segmented disc. That is, it is not a whole ring rotating, they're rollers. It's like a ring cut up in sections.

J.T.- So the rollers go around the outside of the plate?

J.S.- Yes. You have 3 plates as we call them. You have 3 solid rings with rollers in between on the outside of them running around. So that means you've got an inner ring with the inner section of rollers running around. The second ring we call the solid ring or the second plate or the middle plate and its run of rollers and then the third plate with the third set of rollers. You could go on and on but the cost is not worth it. Now what happens is each ring's set of rollers run at two and half times the speed of the one proceeding. So the middle ring rotates two and half times faster than the inner ring and the outer one is two and half times faster than the middle one. Your kinetic energy is building up, your potential energy is building up and this is the only engine I know in the world where the potential energy and the kinetic energy goes up together. The kinetic energy takes the potential energy up fast and brings the potential energy up to an immense level.

## DESCRIPTION OF SEG PLATES AND ROLLERS

J.T.- Now I was looking at in the old newsletters. It said that in the flying craft only the inner ring was stationary.

J.S.- No, either that was printed wrong by the chap who wrote it or he misunderstood. All three plates are stationary. They are part of the structure. There are two actions in the generator, no matter what generator it is that you make, whether it's gas, electric or whatever it is. You've got to have one fixed part which can be the field, or the rotor, and a moving magnetic field. Or you can have a stationary magnetic field and you can have a rotary conductor.

J.T.- Yes, it didn't make any sense to have the plates moving.

J.S.- Yes, you see they become part of the solid structure, the craft. And the rollers have to be shorter to allow free movement. And this is what we've always shown in our demonstrations of the plate and rollers. The roller is shorter by about a quarter of an inch at the ends. So it has complete freedom. It doesn't run off. It doesn't jump off. It just runs along that beam.

J.T.- And on the flying craft they have to be smaller as you get toward the rim.

J.S.- Yes, you make them smaller but you make them thicker. So you've still got the same mass. They are larger in diameter and shorter. But not in a generator. In a generator you keep them all the same size.

J.T.- Oh, I see. So you have to refigure your dimensions because your rollers are going to be fatter.

J.S.-Yes, you see as you go outwards you've got to have more mass. So you go up in the level of the square. You've got to go up in any case. Even in a domestic power unit you've got to go up for each ring, you've got no choice. With the disc, as you go outwards the height becomes less. Now that's when you're building a small model, unmanned. When you come on to something big, like Starship Ezekiel they would be all the same size, because you've got the space. Why we had to go thicker on the outer ones on the unmanned models is because there wasn't the space. We had to maintain the right weight, the correct weight. It had to be kept there.

J.T.-And you had to maintain your seven degree angle too. (The acute angle at the rim of the craft)

J.S.-Yes. So you have to look at that point. People don't think about those things when you're talking to them. They don't think about what is involved. They think, "Oh that must be simple.", and there are a lot of problems that have to be solved.



## SEG IS A PRIME MOVER

J.T.- Now you mentioned somewhere in the newsletters that the SEG is first of all a Prime Mover.

J.S.- The prime mover is really the actual generator itself. The prime mover is the thing that actually does the work. And then you have the generator. Now the prime mover is the thing that has got to move to produce electricity. The SEG is a prime mover, not a generator. The generation comes about thru its action. So you don't have a generator separate. It's all housed in. You can't have generation unless you've got the mover. The trouble with all forms of generation is you have got to have a prime mover. It can be a water wheel, a wind mill, an electric motor or any other type of device. Something consuming energy to produce the motion, to cause the generator to produce power. That is the basic law in physics and science for producing power.

J.T.- So the SEG is actually the prime mover.

J.S.- The SEG is purely the prime mover but is also the generator. You see it's very difficult to explain the SEG in writing because they are brought up with the fact that in order to generate power, you've got two precise units. Now the SEG has two precise sections. A stationary plate and a moving plate. But the moving is self-induced, so it is a prime mover. It is moved by the surrounding atmospheric conditions, the magnetic fields. And that's the bit that no one can understand. Nobody can understand why rollers run when you haven't got them coupled up to something to make it run. And I can assure you that scientists, well known men, have been sitting there watching it and literally pulling the hair out of their head! Trying to find an explanation. And to explain the explanation to people, they say it accelerates. And I can assure you John, they never accelerate. And you can prove it if you had a long enough bar and mark off every foot and put time clocks to start instantly when the rollers moved, you will see that it took just the same amount of time to get to the first clock as the second clock and the third clock.

J.T.- No matter how much load is on it?

J.S.- No, it makes no difference. Because the temperature changes.

J.T.- Oh, I thought the rollers sped up.

J.S.- Well they do when you go to fantastic power, but the average person turning on a light doesn't alter it, only the temperature alters. But if you stuck on an electric cooker with all the plates going and an electric motor, and then you'll find that she starts to speed up, but she instantly goes to the new speed level. The clocks will still show that it has done each step in the same time but in probably half the time it was doing it before it had the massive load put on it.

## DESCRIPTION OF ELECTRON ACTION IN SEG

*I asked John to describe the electron action in an SEG.*

J.S.- What it is, is it's a PRIME MOVER of electrons. You are doing it by the nuclear field being set up in such a way that the forces reacting between themselves is causing a displacement in one direction and giving energy and force to passing the electrons. It's quite a simple thing but everyone seems to miss it. People forget that magnetism turns the whole universe around. It directs all the forces. In an SEG it is a special way that the poles lay up due to the reactions from the nucleus of the elements that causes it to operate. It is that print that makes the rollers run. The atomic forces have to be lined up correctly and you can only do that from the squares.

When you lay the rollers on the surface, when you let go of it, it immediately shoots forward. If the print is right it continues on forever. It is an oscillating field. And the rotating field is created when the roller revolves around its axis as it rotates around the plate.

You make a reduction in the size of the atoms as you come outwards. The reason is you are compressing the electrons passing through. You are forcing them to accelerate faster. You are compacting more electrons in a space at the end and this means that when they arrive on the first roller, the electrons made available to it has multiplied immensely. Then it shoots these onto the next plate so the next plate has an abundance of electrons to give away. These are accelerated and built up, then compress even harder. By the time they get to the next roller they're many times greater in energy level. By the time they get to your third roller, before they're thrown onto your coils, you have terrific energy. That's a small engine to do the job of a bigger petrol or diesel engine as a domestic power unit. You've got a small box doing the same job.

## SEARL'S FLYING DISCS

**J.T.-** Tell me about the flying crafts.

**J.S.-** Those we use for lifting. We call those vehicles Inverse G Vehicles these days. We used to call them Levity Discs, but now that we are absolutely certain that gravity inverts we have changed the name. Actually what is happening is the engine has become a super conductor and therefore it is repulsing the earth. So that's why we call it Inverse. There's so much power from these things. Because, you see, they're so cold when they start over running. That was the problem. I didn't realize that if you design something for a certain level of power, if you exceed that level the temperature drops. The higher you exceed that power level the colder it gets. At last it gets so cold it inverts and it lifts. But the trouble is, it lifts with such force that it ruins your ceiling.

**J.T.-** YES! I'm surprised it gets colder rather than hotter.

**J.S.-** Yes, it gets colder and colder, the more power you take from it. So, for flying, what we simply do is make an engine that when running idle, as we term it, we're not flying, it's just under overload. There's a load on it just enough to hold it from shooting down in temperature. As soon as we start-up we put a bigger load on and down goes the temperature, the gravity inverts and it lifts. On the flying machine you have got to take it into overload to go airborne. So you see we load the power unit so it is running just under overload when it's on the ground.

**J.T.-** Is that what the load cell is for?

**J.S.-** Well the idea of the load cells is to pass a heavy current thru the elements, top or bottom. And thru the center point, out. So you're delivering very highly accelerated electrons out. Very highly negative out into the atmosphere. Well when you get a good heavy stream of them, the atmosphere is forced to bend back. So you are producing a bow wave around the craft. And the atmosphere is being forced to bend away from the vehicle. And it's the same for any object coming toward it. The bow wave is forcing it to bend away.

**J.T.-** So do you vary the resistance on the load cells?

**J.S.-** Oh yes. You set up the resistance in the cell to depend on how sharp of a rate of change you want.

**J.T.-** But the electron flow is all coming from the SEG and going to atmosphere right?

**J.S.-** Yes, All you're doing is you are causing a condition to occur above or below the vehicle and all the time around the vehicle to maintain it at a steady or constant level. So when you are flying forward, remember that the craft is flying at a tilt of roughly

### *Chapter 3*

14 degrees. Now the ring, that force field around it, the bow ring, protects the structure. But it also does more than that, it's what keeps it there level and constant. And if you cut a chunk out, it means at that point you haven't got the force propelling you.

J.T.- Oh, so you are just denying power to a certain point.

J.S.- That's the first thing we do, but at the same instant you have a plunger that strikes the roller just passing. And that causes the gyro effects to take place.

J.T.- You'd think it would damage the roller.

J.S.- No, it doesn't. It's rubber. But the fact that it just hits it, because it's in motion at right angles to the impact, it doesn't damage it. What it does do, it sets up an oscillation wave in the system. But it also causes it to tilt, quick.

## INERTIA AND GRAVITY INSIDE THE FLYING CRAFT

J.T.- Remember when you told me that you don't feel the acceleration inside the disc? How did you measure that?

J.S.- Well we had all sorts of pressure gages and we had stress gages of all kinds in them and torque gages. And what we found was that all measurements that were showing on the graph, it was a tri-pen recorder, showed that the biggest stress on the craft was when it was idle on the ground. As soon as it was airborne everything was at zero! We thought at first that the equipment was faulty, but when it landed, back came the original signals again. Then we tried another company's equipment, but they all came out the same.

So what we did is, we put in a very thin bottle of radioactive material. The idea was that bottle would crack easily as soon as you got up to about 2 G's. There would be no question that it would crack. But when it returned it was still complete, and we reckoned that we must of hit 20 G's at some point of that demonstration. And the bottle was complete.

J.T.- But you have artificial gravity inside the craft, right?

J.S.-Yes, that is artificial gravity of about 1/2 G, the instruments showed. Within the craft that 1/2 G is constant no matter how high you take it. It doesn't get less. No matter what you do, that remains constant. It is produced by the power unit. And that is very good. It would be very comfortable. It's just half of the load that you're suffering now.

*This section is based on an article in the SNSRC newsletter, dated June 1, 1968.*

## **WHAT MAKES THE INVERSE-G-VEHICLE FLY?**

### **Glossary of Terms:**

#### **Space or "Space Fabric"-**

In this context means the three dimensional medium which supports matter, force fields and radiant energy. It does not mean specifically interplanetary space, but includes it.

#### **Ether or "Aether"-**

Another name for space, but implies a different concept in that space is regarded as the absence of matter, and ether is regarded as the existence of a space medium having specific properties, re: O. Lodge theory.

#### **Inertial Mass -**

Comparison of amounts of matter by examination of the inertial properties using the equation:  $P = m a$  where  $P =$  force required to accelerate inertial mass ( $m$ ) at an acceleration of value  $a$ .

#### **Gravitational Mass -**

Comparison of amount of matter.  $G$ , the force on it, is a gravitational field.

$P = Emg$ .  $P =$  force on mass  $mg$  in a field of strength  $E$ .

$E$  is given by the Newtonian Formula.

$E = \frac{GM}{d^2}$  Where  $G$  is universal gravitational constant,  
 $d^2$  is distance from planetary body mass  $M$ .

**Primary Magnetism** - A large scale movement of ether.

#### **Glowing Magnetism, Glowing Core -**

A center where ether is converted from undisturbed state to perturbed states giving rise to various manifestations of primary magnetism, e.g. gravity, magnetism, electrostatic fields, matter, and radiant energy.

**E.M.F.** - Electro motive force, potential difference produced by separation of charge.

**Inertia** - Reluctance of matter to change its state of motion.

**Levity** - In opposition to gravity.

**Microcellular** - Made up of very small cells.

**Macrocellular** - Made up of quite large cells.

**Vortex** - Circulation in a fluid.

**Microvortex** - Small area of circulation.

**Quasar** -

Very small but highly dense star with a fantastically high gravity, producing a large "red shift" in the spectrum of the star.

**Exothermic** - Giving of energy (usually heat).

## BACKGROUND THEORY

The Searl Effect type of craft is a fact. The following theory is offered as to its means of operation.

A theory to cover force fields of all types should attribute a fundamental cause to interaction of matter at a distance whether the interaction be gravitational, magnetic, nucleonic or electrostatic. Present theories include interchange of virtual photons or mesons, and multidimensional distortion of the space-time continuum. Whatever the argument, it will depend basically on the concept of a medium to support the wave motion, flux or distortion. The medium is space and the properties of it have never been seriously investigated, neither practically nor theoretically, that is excepting the possibility that it has been overlooked. The accepted idea is that space is empty, a place with the absence of matter, devoid of tangibility. This is taught to our children as being a primary contention, and is in fact wrong and negative thinking. We do not understand it so we turn our backs to it.

Physical investigation of "space" is impossible, for the experimental technique demands use of apparatus which is made of matter which in turn occupies space.

One of the fundamentals of the experimental method is that the materials and principles under investigation cannot be included in the apparatus. This was but one failure of the Michelson-Morley experiment. In its original form, this experiment was set up to test for ether drag due to the passage of the earth through the medium, but has been assumed to have been an experiment to actually test for the existence of an ether. Failure of the experiment to give a positive result made it possible to interpret the negative result as favoring the nonexistence of the ether as Oliver Lodge imagined it. The then-developing materialist philosophies took the opportunity to discredit the pseudo-scientific religious cult of spiritualism, in which the idea of spiritualism, in which the idea of an "etheric existence" was an important part of the philosophy. As it happened, the two etherics need not have had any connection except in the choice of words. The ether theory was dropped and the spiritualist cult subdued. Today, the Michelson-Morely experiment has been modified to show Doppler interference between coherent wave trains. One wave travels against, and the other with the direction of rotation of the whole apparatus. Results are in favor of the theory of relativity, but can also be interpreted in favor of "ether drag" within the stationary medium about the apparatus.

A vacuum transmits radiation and force fields, so to refer to it as being empty is inaccurate. Real emptiness must include in its definition reference to its inability to propagate energy. Such may be better termed "hyperspace". As to whether hyperspace has the dimensions of space and time or not is a topic for more thought. It is easier to attribute the dimensions to the space fabric in hyperspace, the ether.

The idea of an energy continuum throughout space occurred to Dirac. On the basis of his theory, matter particles emerge from a ground state and become physically Observable. Material above the ground state has a higher energy than the ground state and so requires energy to be dislodged. The energy corresponds to the total energy of the particle, its mass energy ( $mc^2$ ) and other potential or kinetic energies. The theory, then, supposes that matter is of the substance of the ground state, that is, "empty space". In comparison, the Lodge theory supposes that the ether has a maximum of energy, and matter particles are a lower energy precipitate from the ether. The same idea, but a difference of sign. However, this implies that the appearance of matter is a preferred state, and that the creative process is a naturally occurring condition.

Heisenberg, in formulating the "unified field theory", assumed a space fabric of some nature. To quote from the Lindau Conference, 28th June 1962, "The discovery shows that the different elementary particles are not Nature's building bricks, completely independent of each other, but many different forms of a fundamental substance manifest as energy". From then on, the "fundamental substance" is forgotten. "The multiplicity of these forms corresponds to the multiplicity of the mathematical symmetries of the basic equation".

Sir Oliver Lodge imagined the space fabric as having a microcellular structure, each cell being a vortex whose size was of the order of the size of the fundamental particles, or even smaller. The medium was frictionless and the rotational velocity of the vortices related to the velocity of light. The intrinsic energy of the ether was in the motion in the vortices. This attributed an ultimate energy source to space itself. Lodge also imagined that the ether had an enormous inertia and density. The inertia in mass was due to the ether in it, and solidarity of matter was virtual.

A similar idea occurred to Karl Schappeller of Castle Auroldmunster in Inviertel, Austria (died 1947). According to his philosophy, a change in the space fabric (static potential) gave rise to so-called primary magnetism which may be interpreted as a type of autogravitation. This primary magnetism caused a gathering of the surrounding space fabric and from it issued more fundamental energy as an intensification of the primary magnetism. At a certain stage, the system reached an equilibrium gathering space fabric, and from it precipitated energy. When the energy density reached a required level, matter would be produced. The system would take up a spherical form in the "natural" state and become what Schappeller called "glowing magnetism". Glowing magnetism, he claimed, constituted the core of all planets and suns, the gravitational core of which was due to the glowing magnetism at its core. How this theory fits the universal law of gravitation is at first difficult to see.

We must remember that the universal law of gravitation is based on Kepler's Laws, which were derived from astronomical observations of the planets. The masses of these bodies can only be determined from their gravitational interaction, not from



their inertial properties. Hence for cosmic bodies the term  $m$  in the derived formula  $E = G \frac{m}{.19}$  is not necessarily related to the inertial mass of these bodies, but the gravity of them. Gravity cannot be proved to be due to the mass content of these bodies by astronomical observation only. Further, no convincing experiments have been conducted to prove that static inert matter has any gravitational field. Experiments, like that of Airies, which use the earth as a mass, are questionable on the basis that the gravity may be due to the earth's field alone. Boys' and Cavendish's experiments showed only that masses in relative motion have a force between them, since in both experiments the masses were in torsional vibration suspended by a beam. The force could be attributed to an inductive or relativistic effect between the charged particles constituting the masses.

Hoyle, from his work on quasars, has deduced that vast cosmic masses could undergo gravitational collapse leading to a singularity and that the converse was possible. A singularity could explode into a creation field. This is much the same idea as that of Schappeller, though on the basis of his theory the creation process is much less dramatic. Hoyle's creation field arises from nothing, whereas that of Schappeller, glowing magnetism, arises from the space fabric. Which is the more plausible?

Physical evidence for the existence of glowing magnetism may be available. The source of energy in comets has long been a problem. How a comet can give off so much radiant energy and continually dissipate its matter in the tail, yet despite its apparent lack of substance survives to return after many years, is difficult to explain in terms of conventional science. The usual explanation is, of course, the energy is reradiated sun's energy. Who has proved it? The existence of "ball lightning" has now been accepted but as yet eluded explanation, except that attempts have been made without the usual mathematical substantiation. The peculiar anti-gravitational effect, the inductive effects and the fantastic energy of ball lightning fits neatly in with Schappeller's theory of glowing magnetism. The glowing ball of polarized space fabric is precipitated by enormous static fields or high current pulses in thunder storms.

At a center of glowing magnetism, the space fabric is modified and the energy condensate comes off as magnetic fields and radiation. The consumed fabric is replaced by an influx of the surrounding space. Matter particles in the surrounding space would experience a force towards the center. This would be a gravitational field. Lodge imagined that the ether would be near incompressible with a very high elasticity. A small inhomogeneity would give rise to a relatively big effect. Also the ether flux would be at the velocity of light and bunched in much the same way as magnetic fields bunch at high intensity. Thus the maximum velocity of a matter particle would be that of the velocity of light and the approach to that velocity, an exponential. Can the theory then explain cosmic gravitation? If so, there must always be a magnetic effect associated with it.

The name "glowing magnetism" implies that Schappeller considered this to be of prime importance. In fact, he maintained that the magnetic field produced by a glowing core was different from the familiar type of field in that it was a dynamic field, not static. This is consistent for an energy source with indefinite energy could produce a continually expanding flux. Such a dynamic flux would be capable of induc-

ing a D.C. in conductors. As a secondary effect, the currents would produce a static magnetic field of the usual type. A cord of a cosmic body then would produce dynamagnetism which would be absorbed by matter to produce a magnetic field. This field would have to be a function of the gravity of the theory is any good.

As it happen, a reference to related work can be found. Prof. P.M.S. Brackett, quoting from the works of Schuster, Sutherland and H.A. Wilson, showed that the magnetic moment  $P$  and angular momentum  $U$  of the earth and sun are related by the equation:

$$P = \frac{B G}{c}^{1/2} U \text{ where } P = 1$$

$c$  is the velocity of light and  $G$  the universal gravitation constant. The relationship holds for Bohr magnetrons, and support for it appears in DeBroglie's equations for mass waves. It is interesting to note that the formula also includes rotational motion. Particularly, the equation relates angular momentum, magnetic field and gravity. Angular momentum is known to be related to gyroscopic restoring couples. Although

gyroscopic action can be dealt with mathematically, no physical explanation exists for it. In view of the fact that a vector is required along the axis of rotation, might this not suggest that rotating matter generates a field along this axis? As yet, it can only be postulated that the field couples the gyro in a fixed orientation in the space fabric. This direction sensitivity suggests isotropic qualities of the space fabric. Lodge imagined that this might be so.

Magnetism at one time was regarded as separate from electricity until the electromagnetic effect was discovered. Then the problem was: "Is electricity a form of magnetism or is magnetism a form of electricity?" Einstein showed, however, that magnetism was a relativistic effect due to the movement of charge, thereby identifying magnetism as being a form of electricity. From thence sprung the concept of electron spin which fit a good theory to explain permanent magnetism. Much work is being done on spin resonance which further supports the theory. However, the discovery of magnetic monopoles indicates the possible existence of magnetism without charge and that magnetic lines of force need not be continuous. This raises questions as to the exactness of the Theory of Relativity and Electromagnetic theory in their present form.

Schappeller regarded magnetism as more fundamental than electric current, and that current was flowing magnetism in the conductor. The field of influence surrounding a wire was an externalization of the flux within the wire. The field, therefore, must be regarded as flowing parallel to the "current" in the conductor. The mathematical treatment of such a configuration leads to the same practical results as the conventional idea of magnetic flux as being perpendicular to the current flow. The actual nature of current and magnetism, being one and the same, may be visualized as large scale flux interspaced between the Lodge microvorticies. Such a flux must result from the breakup of the microvorticies and therefore will appear as a form of energy potential. Conventional magnetic field may be regarded a form of potential energy.

If we accept that magnetism is more fundamental, then a consistent explanation must be found for static potential, induced E.M.F. and electrochemical potential. A conductor forced through a magnetic field interacts with the macroflux of the ether ahead of it and absorbs the flux in a direction depending on the direction of the macroflux. This constitutes the current in the conductor. The flowing magnetism in the conductor reconstitutes the macroflux behind it, the energy being derived from that which forces the conductor. If the conductor is open circuit, an E.M.F. is set up. This is like electrostatic potential, in that it is static magnetism, the polarity depending on an excess of ether at the point at higher potential compared with that at lower potential. Since the ether tends towards uniformity, then an ether flow will occur under suitable conditions to relieve the strain. This constitutes flowing magnetism which is current. The flow in the conductor affects the surrounding ether, giving up some energy to it, creating macrovortices, which is a magnetic field.

An electrochemical E.M.F. is an expression of the energy available from an exothermic reaction but in a potential form. When current flows, the reaction takes place and the potential chemical energy is dissipated. Schappeller regarded chemical bonds as a static form of magnetism in the same way that static electricity could be regarded as immobile magnetism. Matter particles being an ether precipitate cause permanent density irregularities in the ether. Chemical bonding or particle bonding lowers the stressed condition of the ether releasing the retained ether, or static magnetism, as some form of ether disturbance. This could be ether waves (radiation), macrovortices (magnetic field) or flowing magnetism (current), which are all forms of energy.

Looking back over the theory, it is seen that in glowing magnetism the space fabric is destroyed as microvorticities and the resultant residual flux appears as large scale flow patterns in magnetic fields or macrovortices. If this primary magnetism reaches high values, the flux interferes with the surrounding space fabric to produce matter particles, so being partially reabsorbed. Radiation can only be produced by matter particles, so that once matter has formed, energy may leave the creation field as radiation from the particles which are stimulated by the magnetism.

The primary magnetic field of the Schappeller glowing core is different in a very fundamental way from the usual type of field. In a perfect conductor, if the E.M.F. is maintained, the current increases and hence the magnetic field. That is, as long as energy is supplied to the system the field expands. In a resistance, the energy is dissipated as heat and the field is constant. In the Schappeller primary field, the flux is continually supplied as the energy is created, and therefore the field continually expands. This is dynamagnetism and an ordinary magnetometer is insensitive to the field. A conductor in the field will have an induced current and thereby produce a detectable static field. The instrument to detect a dynamagnetic field must consist of a loop conductor with a magnetometer at its center.

If, as Schappeller states, the earth has glowing magnetism as its core, then it should produce dynamagnetism. Most of this would be absorbed in the material of the planet and produce the static field. If any of the dynamagnetic field did penetrate the surface, it would be difficult to detect against the background of atmospheric disturbance and static field. In his early experiments, Riech did detect and accumulate energy from the earth which was other than natural radiation. A core of glowing magne-

tism would be and would have been in the process of producing matter. The earth would have been expanding from the center since it first formed. This was the best explanation for "continental drift", but a reason for the expanding earth could not be found. Geographers would welcome the idea, for the land masses have been shown to fit neatly together on a sphere of about half the size of the earth.

The creation fields or glowing magnetic cores at the center of cosmic bodies must somehow originate. Schappeller's argument as to the origin is more difficult to follow, because of terminology, than the rest of the theory. It seems, however, that when a sun becomes large enough to form a crust, the very process of doing so causes a focusing of the various fields which starts up a new flowing core making the center of the new sun. The old sun has its supply of ether cut down and the glowing core is subdued but not snuffed out. It becomes a planet of the new sun with an apparent reduce mass due to the drop of gravity and reduced size as it initially cools and contracts. The core of the planet is not yet finished, for it continues until the crust becomes very thick and finally cuts off the ether supply. Then the core does die and the planet loses its gravity. Only molecular forces remain to hold the planet material together and if the internal pressure is high the planet can explode.

This clashed with the conventional ideas, but thought out in detail equally explains observation. It does go one better in that it adequately explains some facts not covered by the conventional theory, the asteroids, for example.

Other than providing a fundamental explanation for the organized universe, Schappeller went as far as to design a device using and converting the fundamental substance into useful energy. It was designed to produce a glowing magnetic core in a vacuum which then is self-sustaining. Basically it consists of a pair of coils wound on to a hollow ceramic form, shaped spherically and contained in an iron sphere. The coils are of copper tubing packed with a permanent electret material. This constitutes the dynamagnetic generator. To convert the energy into mechanical energy, a rotor is used, also made from copper tube packed with electret. The sphere functions only after the electret material is polarized.

Because of the terminology in the Schappeller theory, to is naturally difficult to follow, that is, apart from the strangeness of the concepts. After several readings, one might conclude that "glowing magnetism", or ether precipitation, starts if the electric and/or the magnetic fields reach enormous values at a given point. It seems that this is the function of the stator device outlined above. The arrangement of the fields must be such that a reduction in the density of the ether occurs instantaneously. An immediate influx of ether occurs which continues under its own inertia. The resultant compression then causes the production of energy which appears as (radiation and) magnetism. By this process it would seem that an oscillatory state is set up. This may be so and the frequency related to the size of the glowing core. One might expect some sort of longitudinal ether wave to be set up which would be entirely different to the transverse waves of electromagnetic radiation. The wave would cause variations in the ether density which would mean that matter would tend to occupy regions of maximum density in the wave and that the velocity of light would vary slightly between maxima and minima.

In the case of the earth, the Van Allen belts could be taken as an indication of such gravity waves, and for the sun, the obvious fact that the planets occupy orbits that are harmonically related. In both cases a standing wave is indicated. It might be worthwhile research to look for variations in the velocity of light in the Van Allen belts.

Lodge deals with the problem of inertia by attributing the property to the ether itself. Matter, he claims, has no inertia as such, but acquires an induction as it moves through the space fabric, or more correctly, the space fabric moves through it. The induction constitutes a change of energy seen as kinetic energy, and the state of motion lasts as long as the induction lasts. The theory also asserts that the ether itself has an enormous inertia and is in a preferred state of rest. Small movements give rise to big effects, for example as in gravitational fields. However, small movement does not mean slow movement. The idea that the cellular vortices circulate at the speed of light might be extended to larger fluxes. The conclusion to this is that matter accelerated by force fields cannot exceed the speed of light and the approach to it would be exponential.

### APPLICATION OF THEORY

The ultra high potential produced by the Searl ring generator being so much greater than the ionization potential of the air, causes ionic breakdown of the air at some feet from the craft skin, as this acts as the positive electrode. The negative side of the generator is connected to the periphery of the disc, and isolated from the skin. The field at the negative terminal is therefore very much greater and the air is ionized at a greater distance at the rim. The air at the positive terminal loses electrons and the resulting ions are repelled from the terminal with high acceleration. The electrons pass through the generator, constituting the current in the generator, and provide the charge at the negative terminal to produce negative ions in the air near the rim. The craft therefore is enveloped in a vacuum.

In ordinary high voltage generators the maximum potential is limited by the ionized breakdown of the air. Flashover occurs and accumulated energy lost. The geometry and the arrangement of the field coils in the Searl generator is such that flash-over is eliminated until the thing is in a vacuum and then is impossible.

Energy is required to build up the potential and initially has to be supplied from an external source. As the vacuum layer increases about the craft, less energy is required to maintain the potential. The generator soon reaches a potential when the Searl Effect takes place and the device produces its own energy along with the levity phenomenon. On the basis of the theory, at this potential the stress on the space fabric cannot be equalized by flowing magnetism (current flow) through the air and craft as a circuit. The space fabric breaks down to provide the magnetism to relieve the stress, but the energy by-product is absorbed by the generator which reinforces the field.

The generator then must set up an ether flux along the lines of the electric field as is conventionally represented. The direction of ether flow is, however, in at the positive and out at the negative. This is deduced from the Schappeller theory. The generator and craft therefore produce their own gravitation type field.

The net effect of the craft field plus the earth's gravitation field gives rise to a condition where the ether density below the craft is higher than that above it. The craft therefore is strongly repelled from the planet. And to stop it from shooting off into space the field of the craft must be intentionally perturbed. In the drive condition, the field is as shown in fig. 4 and the craft is shot out of the earth's field like a wet orange pip from between the fingers. The acceleration is enormous, but since all matter associated with the craft is linked with the field no distortion of any part, including passengers if any, occurs. The limit to the speed is unknown but since the craft has no inertia there is possibly no limit. It would be safe to say, however, that the limit is below the speed of light. Above this speed too much is unknown to take the risk, but since the craft carries its own space with it the theory of relativity is inapplicable. In fact, the craft does not travel through space but past it.

It can be seen from the gravity field diagram that a neutral zone appears below the craft as well as the neutral ring above, when the levity drive is on. If matter becomes located in the zone, then it is held there. In consequence, the Searl craft so far made have left their mark on the countryside in the form of large, neat holes when they suddenly take off. The chunk of earth is taken up with it.

The gravity field within the body of the craft is such that the center is up and the rim down. If the generator is allowed to "run up", because the polarity is opposite to that of the Schappeller machine, the field is expansive and pulls the craft apart. Prior to this, glowing magnetism could start, characterized by an orange-yellow glow, but could not become self-sustaining, being expansive. The Searl generator runs at low speeds and is unlikely to fly apart by centrifugal force. Apart from this, the side effect electromagnetic forces help to keep it together. As with other gravity fields, the flux favors passage through matter and so the field within the craft may be tailored by appropriately distributing the mass in the craft. This is of particular convenience in manned craft where the comfort of crew may be improved by making the cabin field about one half G.

The external field, when the craft is travelling in free space, would resemble that of the combined earth and craft, since it would be moving relative to a stationary ether. Collision between the craft and large objects in space is very unlikely except in direct line of flight when such could be seen and the craft rapidly turned. The field is such that the objects are diverted past the craft, or it past the object. If the object qualifies as a planet or moon having its own gravity due to a glowing core, then the craft oriented by the interaction of fields is strongly repelled away unless measures are taken to alter the field of the craft. Small objects such as meteorites are pushed out by the combined electric and dynamagnetic fields. An object entering such a powerful static field is at first attracted, then ionized and then strongly repelled. The dynamagnetic field induces a magnostatic (ordinary magnetic) field in objects which will interact with the craft magnostatic field at considerable distance (miles) and repel it.

It should be pointed out that only a very small amount of space fabric passes through the craft and an even smaller amount is converted for energy. However, as previously mentioned, small changes in the ether lead to large physical effects.

Even in deep space the craft has an electronic flow through the generator which is continuous along the electric field outside the craft. Electrons are picked up and some leave the rim at relativistic velocities. These do not contribute to the drive. So the craft also carries its own negative space charge. In an atmosphere the electronic flow is much greater, and the generator current much higher. The craft therefore functions a lot better and has greater flexibility in space. In air, the recombination of ions gives rise to a pink to blue glow around the craft and in damp conditions the ions in the air can give rise to condensation. This effect coupled with the output of electrical energy could well precipitate thunderstorms.

The only hazard so far observed is that if the craft hovers for too long low near the ground the soil becomes burnt due to the electric currents in it which build up heat. Also the nervous systems of animals are interfered with by ionizing discharge if they get too near.

# CHAPTER 4



*This chapter will deal with Searl's successful period when everything was in full swing. At this time there was great interest in his work by many countries and hundreds of people. This period lasted until 1983.*

The following are some of the many sources of the publicity that John Searl got.

1. Life Magazine, USA
2. Thames TV Program "TODAY" , Great Britian
3. Saturday Post Magazine, USA
4. Saturday Tidbits October 2, 1971, Great Britian
5. Hants and Berk Gazette, Great Britian
6. John Drysdale, of Camera Press LTD., Photographs, 9 19,1971 G.B.
7. Southern Television, Producer Mike Connor, April 23,1972, G.B.
8. U.S. Bureau of Astrodyanautics, 1974 USA
9. ATV Television, Great Britian
10. BBC 1, Television coverage every month. Great Britian

All the above have done articles, taken photographs or televised John Searl's work. This by no means is a complete list.

### **DEMONSTRATIONS OF THE SEG**

*I asked John if there were demonstrations of his generator.*

His reply is as follows:

We showed all sorts of things. You must have read an article by Bill Sherwood where he said he saw a demonstration of circular magnets that rotated. And as soon as you brought the bar in to close the system they started rotating. There was no input. They were running on there own.

J.T.-Are these the rollers that ran completely around the bar?

J.S.- They run round yes. They run right around the bar, up one side and right around the corner and down the other side. Gunner Sandberg remarked that he'd never seen rollers run along a bar, turn round the end and down the other side and up the other end and around passing thru two right angles at the end without loosing speed. And although the bars have definite magnetic poles at each end to hold the roller, you can pick the rollers up on the end of the bar and shake it and they don't come off. Why do

they just pass by and go around and up the other side past that end and don't stop? They don't stop but they should because you can pick the rollers up with the bar and shake it and they don't come off. So there are definite poles but they're both the same. Each end is the same pole. He remarked on this that it was really hair raising. Now we had a lot of letters from scientists that wrote to other scientists telling them about the demonstration. And they have never seen rollers that simply pass thru two right angles so close together without slowing down or stopping.

## THE SEARL EFFECT

You see, the Searl effect is only to make the rollers rotate. Because until they rotate no energy will move. You've got no moving flux. What is happening is you're cutting your lines of conductors by magnetic flux that you do in any other generator. There's nothing different there. But the only difference we are doing is we are at the same time inserting electrons into the windings. Whereby in normal conventional engines you push them away. You don't insert anything. Therefore every time you switch off a switch you lose an electron or two. The light loses an electron or two. In this case every time you switch on or off you're putting more electrons into the system. We're putting electrons into the system instead of taking them away. So you're building up the system. We're doing the opposite actually to what they do. Of course we're not like other manufacturing companies. It means less bulbs will be sold, less cable will be sold, less switches will be sold. But, the way I look at it is this- If people have free energy, then they'll buy things to use on it. If energy gets dearer and dearer each year, less goods are bought to use on it.

## FIRST SEG GENERATOR MADE

J.T.- When you first made your magnets, you had to have them pressed, you had to make them yourself. How did you ever do that?

J.S.- Well the first thing was, I was lucky. I worked for the Midlands Electricity Board in 1949 and we had all the equipment. Everything was there. What it was, the chaps were laughing at me. And when you're in charge of eleven areas, the bosses don't like their bosses being laughed at and mocked. So they said to me, "Well you have three options. First, shut-up. Second, do it, or third, bugger off." I didn't like the idea of bugging off. I didn't like the idea of shutting-up. Because I somehow knew I was right. And I didn't see why I should shut-up if I was confident that I was right. They said, "You got all the equipment here, you just tell us what you want in material. We'll get it. All you need to do is pay us the bare costs of the material."

J.T.- Boy, you were lucky there!

J.S.-I was lucky. I was placed there by chance. Just chance I got that job. What happened was, the landlord I moved in with, he had an old radiogram and it wasn't working. Now I asked him why he didn't use it. He said, "It doesn't work". I said, "Haven't you taken it for repairs?" He said, "Yes but it would be cheaper to buy a new one." I said, "Well, do you mind if I look at it then?" "No", he said, "Go on!" Well I opened it up and saw what the problem was. And I went down to the parts shop and got a replacement part. It cost me two and six of my own money. Brought it back, plugged it in, switched on. Beautiful. Sound blasted out there so I said to him, "What's wrong with it?" He was shocked! It was only two and six pence. So he wrote the Electric Board and said he had a chap lodging with him who seemed very fascinated in electronics. Would they give him an opportunity? Offer him an interview. And I got it during an interview and they asked me a lot of questions and were quite satisfied and I moved straight into an upper position job! No bother!

J.T.- Boy! Talk about fortunate!

J.S.- Yes! Everything was simply planned for me!

J.T.- Yes, It was like it was preordained.

J.S.- Yes, It probably was done before I was born!

J.T.- Yes, You were destined to do this.

J.S.- Yes, I was put in with the right landlady in the first place.

J.T.- Ya, she didn't throw you out on your ear anyway!

J.S.- Right. Most landladies would say, "Pack your bags and go!" "Having you destroy my home like this." That poor woman's nerves must have been made of steel! To put up with me. But she enjoyed every minute. She stayed up every night holding wires for me to solder on. She always would say, "Is the fuse going to blow?" and I would say, "No", but sometimes it did! Then one day when I came home from work she was all shaking and going on. "Caw", she said, "You ought to have seen it. I went to clean the back of the radio set with a wire and it picked me up and chucked me out the window!" And was laughing like hell about it! I said, "You're lucky the window was open!!"

J.T.-Oh no!!!

J.S.- Oh yes!! I've been thru some awful bloody things! I hope someday to include them in the books. Some of the funny things along the route.

J.T.- You really should. They are funny!

J.S.- Because it's marvelous how these things moved in, one after another. At the time it didn't seem funny. But now when you look back, it looks very funny. But now, you see, you can see a purpose. At the time you couldn't see any purpose.

But in any case you can look back now and laugh at the things. You can say to yourself, "I suffered. I endured a lot. I put up with things." I moved from one job I got interested in to another. I didn't know why. But now I know why. At the time you didn't know why. But you had to because you had to have that knowledge and you could only gain it by experience. That is really what my whole life has been about. It has been moved by an unseen force to precise steps of employment for precise knowledge to be gained. And when you gain the amount needed you are automatically moved on, like a pawn. You had no choice. Everything was done. The boss came to you and said, "Look, you're too good for this job. Your destiny is for something far better and bigger. And I'm holding you back."

J.T.- Yes, It doesn't appear to be a good thing at the time but it's for the better.

J.S.- No, that's it. You can never see ahead. You may think things are going to happen but how your life is going to move up to that point, you generally can't predict. And only when you look back, can you see the steps.

## *Chapter 4*

J.T.-I guess it's better not to fight it.

J.S.- Yes. And as I said in this fourth book. Time is our master. We are slaves. And if we serve time right, it rewards us. We are not the bosses.

J.T.- Yes, I think you're right.

J.S.- You see people have read a great deal about me but they have read the wrong things. They only read the highlights and bits and pieces, but no practical information. You see I'm not working to get money. I haven't worked for anyone else for the past seven years. I've been trying to replace and re-work all my figures to remake all the stuff that's been destroyed. Because it's a long job. And what I'm doing now is putting it in book form to make sure, if ever it gets destroyed here, there will be so much proof to replace it pretty quick. Instead of re-working it all again.

J.T.- Yes, that's why we want to get the books out!

J.S.- Yes. It took so long to try to bring all the facts back again. But I hope that when people read about all the studying that's involved for this work, they'll realize that they've been getting misled on what they've heard about me.

## FIRST GENERATOR TRIAL

J.T.- How big was your first SEG to produce electricity?

J.S.- The first one was only about fourteen feet.

J.T.- Fourteen feet? But the first motor was real little wasn't it?

J.S.- No, no. Because I was trying to build a generator. Generators were big things. So we anticipated it would have to something pretty big.

J.T.- So the first one was fourteen feet.

J.S.-Yes.

J.T.- Now what about your little one that took off in your room with your landlady there.

J.S.- They were little experimental things we were doing. Not so much as generators but as a novelty to try to produce a little motor. That did a lot of damage. They stored a lot of energy. I had a very good landlady. She was seventy-odd and she was short, about five foot one. But I can tell you something. She never suffered with rheumatism. Every time I'd switch on she'd jump to the ceiling! She was the fittest women I ever knew!

J.T.- Now on your fourteen foot one, did you just build that like a rim around it?

J.S.- Yes, yes. The idea was that we would take the electricity off the rim. The unfortunate thing was nobody knew that if you overcharge something like this, you over draw power, it would drop in temperature. And when it got down to four kelvin everything we know in physics reversed. And it will lift. We had runners running around. The trouble was that we put in a winding in segments all around the outside to collect the energy. And the thing is, although we were following normal practice basically, of normal conventional motors in the actual collecting of the energy, we didn't know that the amount of energy we would take off would make the vehicle speedup.

J.T.- So when you applied the load to your electromagnet pickups then it speed up?

## Chapter 4

J.S.- It started taking more and more power and should have been slowing down. Instead it started going faster and faster. Which of course is what you weren't expecting. The only thing I liked about it was we had a feeling that something might happen and we decided to test it outside.

J.T.- You're lucky there!

J.S.- Yes. Because otherwise we would certainly been in terrible trouble!

J.T.-I would have liked to see your face when that thing took off.

J.S.- Oh yes, you should have seen everybody's face when it happened! Everything goes dead quiet. I remember a man saying to me, "Man you ought to see your face! It's as white as anything. You'd think you've seen a ghost!"

J.T.- That must have been quite a surprise. You're trying to make a generator and the thing takes off!

J.S.- It takes off and you look a fool in front of everyone!

J.T.- Well...Either a fool or a genius.

J.S.-I don't know. You tend to be the fool. Well! The thing was that when it took off... When we lost six such machines... then you say to yourself, "This is a silly game." If it wants to fly, give it a body. Then you see we can control it!



**BASED ON NEWSLETTER DATED JUNE 1,1968  
Corrected for accuracy of information.**

By 1952 the first generator had been constructed. It was tested in the open by Searl and a friend. The armature was set in motion by a small diesel generator to induce a starting field. The device produced the expected electrical power, but at an unexpectedly high potential. At relatively low armature speeds a potential of the order of 10 to the fifth power volts was produced, as indicated by the static effects on nearby objects. Characteristic crackling and the smell of ozone supported the conclusion.

The really unexpected then occurred. The generator lifted while still speeding up, broke the connection between itself and the generator, and rose to a height of some 50 ft. Here it stayed for a while, still speeding up, and surrounded itself in a pink halo. This indicated ionization of the air at a much reduced pressure: 10 to the minus three mm Hg. More interesting was the side effect causing local radio receivers to go on of their own accord. This could have been due to ionizing discharge from the generator, or electromagnetic induction. Finally, the whole generator accelerated at a fantastic rate and is thought to have gone off into space.

Since that day Searl and others have made some tens of small flying craft, some of which have been similarly lost, and developed a form of control. Larger crafts have also been built, some 12 feet and two 30 feet in diameter.

The antics of his machines have given rise to much speculation as to the nature and origin of so-called "flying saucers." One wonders why Searl has not come to the notice of scientists and to the public at large. The fact is that he has, but, for fear of being ridiculed, people keep the knowledge or interest to themselves. The public has been educated to scoff at the subject of flying saucers, and the reported behavior of things that cannot be explained by current scientific theory. Such "difficult to explain" topics must be given the "no comment" treatment, so as not to upset the uncertain structure of present science theory.

**THE EFFECT:**

Any theory must explain the various phenomena, some of which have been observed by Searl himself and some by the general public. Associated with the Searl Effect craft are the following:

- 1) **Antigravity or levity.**
- 2) **Very high voltage electrical fields.**

**3) The peculiar magnetic effect.**

The generator produces a high density electric field with negative polarity at the rim, and positive at the center. There is also a magnetic field which surrounds the craft, and extends out from it.

**4) Perpetual motion.**

Once the machine has passed a certain threshold of potential, the energy output exceeds the input. From then on the energy output is virtually limitless. Searl explains this by stating that the machine collects electrons from the space around it. The estimated power output of the generator is some 10 to the 14th power watts.

**5) Inertia loss.**

Above threshold potential, which must be some 10 to the 13th power volts, the generator and attached parts become inertia-free. This of course goes against accepted concepts of inertia in mass.

**6) Drive.**

By altering the distribution of potential on the surface of the craft, it is possible to propel it. The preferred direction of travel at ultra high speeds is away from the planet, the plane of the generator being at 90 degrees to the gravity field.

**7) Ionization of the air.**

This is from the discharge of electrons from the generator. It gives rise to a translucent glow surrounding the craft and glowing trails. The intensity of the field is such that it is capable of excluding the ionized air creating a near vacuum around the craft.

**8) Matter snatch during acceleration.**

This occurs when the craft is on the ground and the drive is ground with it, leaving the well-known hole in the ground.

## **DOMESTIC POWER PLANT**

J.S.- The domestic power plant should be nothing much more than about eighteen inches in diameter and about three or four inches thick. That's all. It's a very small unit. What you must bear in mind that plate one and plate two with their rollers are actually the prime mover. The ring three and its rollers is the energy producer. So you still got your two stages as you do in normal and conventional engines, the prime mover then the electric producer. In this case we just compressed it and it's still there. You've got the prime mover and you got the energy producer.

## FLYING DISCS

*I asked John what causes the discs to fly.*

J.S.- Temperature drop gets the whole thing going. The unit becomes a superconductor. It's this arrangement which causes the atomic pattern within the matrix to set up in such a manner that the electrons are caused to move forward. The slower they go down in the main matrix itself the more power can pass through. But the force of the separate nucleus causes that force to accelerate to the magnetic field.

There's a revolving magnetic field out there. So if you've got a space vehicle, a big craft out there, then the gravity field of the earth must produce the same type of energy as the craft because it's acting just the same as the SEG. You are using the gravitational energy of the earth to continue the power of the SEG. Everything is linked to one another. Therefore, the craft is very simple to control in outer space for space travel, because you're tapping in on the fields, the gravity fields, of the different planets and this supplies the energy effect on the craft. The generator itself is a receiver. When you leave the earth, the earth is your prime force and your destination is your secondary force. And eventually your secondary force becomes your prime force and the earth becomes your secondary force.

The skin of the craft is like giant aerials. The magnetic field around the rim of the craft causes the skin of the craft to act like two receiving aerials and act like a magnetic lens to focus on planets. So you've always got something in front of you to be focused on and you always have something behind to be focused on to hold you true. It's a big electrical magnetic lens.

On the model at ground level you have a vacuum around the vehicle. The earth pushes. The pressure of the earth itself. The electrical magnetic field of the earth pushes the vehicle away from it. To stop the model from flying off the earth you have to apply pressure down to balance the forces. The planets become a force on you. You've got to consider your craft and everything within it a separate world. The earth is much greater so it is acting on it. But it is acting in the reverse. It has a repulsing action. It pushes it away. We are a separate planet as our identity. So we have a force like the earth. Because they are two equal, they are pushed apart.

J.T.- When you're inside the craft you don't feel the acceleration do you?

J.S.- No, you don't feel a thing. You are at zero on everything so you rely on your instruments to tell you what's going on outside. There have never been any manned flights because the vehicles were unpressurized and the SEG creates a vacuum. All models were controlled by radio control devices.

There was a picture taken from one craft of another craft. All pictures have been destroyed. For the first time we could show that the craft, when flying is terrifically bright on top and dark underneath. Showing that the energy pulling in on top is

actually being used by the craft. The biggest craft was 48 feet in diameter. The one we want to do now is 129 meters. That will be manned.

J.T.- How fast will the units fly?

J.S.- It will almost squeeze up to the speed of light. In the atmosphere you have to move slower. We must travel above 30 thousand feet because of the density of the air. We have quoted flight time from New York to London as 20 minutes, 5 minutes from London to Germany, 30 minutes to Australia or Japan.

## STARTER GENERATOR FOR P-11

J.T.-I was looking thru the newsletters, and in them I read a description of the first flight of the P-11 which said you started it with a small diesel engine.

J.S.- When we use to start up, we use to introduce a power. But then you see, we found out after, that you didn't need to do this. It was how we had magnetized them that was causing the need of a starting source. Of course another thing that we discovered in those days is you burned a big ring around it on the ground. And it tended to pull the earth up. Any earth that wasn't heavy and solid, it simply pulled up and carried up with the craft.

J.T.- So what did you do? Put voltage on the outer ring to get the rollers started?

J.S.- Yes. Because the field wasn't true. The field didn't come out quite true, you see, and the result was that they couldn't get moving on their own. But we were trying to solve the burning of the ground. What we arrived at was, the forces were focusing at that point where the ring was made. What we needed to do was try to offset the field so the field didn't focus down to the ground. And by changing the coils around and experimenting, we came up with the change required. But now at the same time, we now had a slip between the fields. And that slip introduced a force which set the rollers moving on their own!

J.T.- Oh, I see. So by changing the frequency by just a little bit, you created the slip.

J.S.- Yes. Remember, when we started out, there was no information of any kind on this that you could obtain, and everyone said you were nuts!

J.T.-I see, so what you did was induce a field into the outer coils in order to get the rollers going and once they got going the unit would take over on its own.

J.S.- Once they really got going it was alright. They produce enough source of their own to carry on.

J.T.-I couldn't understand what this little diesel engine was for. It must have been a little diesel generator.

J.S.- Yes. A little diesel generator to induce a magnetic field. But that was because the field, the force, instead of being used to push the rollers were actually focusing to the ground and damaging the ground. But when we toy'd and experimented to try to correct that, we did ourselves a good favor! Because we put the poles sufficiently out of line, to create a big slip that would force the rollers to rotate completely on their own!

When we made a new unit we just changed the fields, the magnetizing fields, so that we produced a different arrangement. But the trouble in those days,...people weren't really interested. They thought you were nuts. So they just made the things to humor you. But they never carried out any tests with the equipment there to verify what was happening.

What happened was, we were working completely blind and we weren't given the encouragement that ought to have been given. They said, "Alright we'll do this to humor him, to shut him up." Instead of carrying out some experiments to find out what the field was like. They weren't interested. They just made the parts and that's it. And so it wasn't until we just recently did the first experiment...and we struck lucky. I did get everything right and the segment came out and for the first time we saw the field. We could take the measurements and look at the field. And I was quite surprised at what we had. It was the dream. Absolutely bang on. You couldn't have engraved it that perfect. If you had engraved the lines, you couldn't have done it as perfectly as nature did it.

*This is a description of the first test flight of the P-11 Levity Disc by John Searl.*

J.S.- The P-11, was the first of a new style of craft based and aimed at solving the problems of design for a manned craft, which some day in the future would be built, which would be called Starship Ezekiel. The beginning of a real Space Business.

As you see in the photo, this is a pleasant looking craft in structural shape. It is 10 ft. in diameter. One can see the cumulus clouds and, (as recorded in the very carefully documented report in my files, along with other photo shots of this craft taken from different angles and heights,) a force of 8 is blowing. She holds and handles beyond all that had been hoped, from past work. She exceeds all our dreams. She climbs, holds at a touch, and moves not an inch against the wind. There is no sound. People around rush to hide from us as if we were some kind of aliens from another world. Yes, they are watching us behind trees and hedges, but none will come near us. They are not trusting us. We are wide open to be seen, yet every one who drops in on us is very quickly in a hurry to get away. It looks quite comical from our viewpoint, watching their reactions. The sun is shining, but it is not pleasant; the wind is cold.

We are quite happy about the P-11. We shall attempt a full launch and run at 1500 hours G.M.T.. We prepared the power supplies to all equipment on the craft. We are very busy, yet from the corner of my eye I can see watchers, but none have dared to enter the field. We have carried the P-11, weighing ten hundredweight, to a position clear of the overhead high voltage lines, otherwise we shall bring the power station to a sudden halt with a lot of damage.

Time is approaching 1500 hrs. The call comes through from Cornwall that all is ready. The carrier beam is on for the run. Now our hearts have increased in their beat patterns and we are sweating, not because it's hot, but because the craft might fail to obey the command signal to pull out of the climb, and continue into space and be lost. One minute to go now. I am still sweating heavily but my knees are shaking quite heavily with a new fear: what if the craft pulls out of the climb before it's clear above the power cables? If it touches those cables or fails to clear at a safe distance, the craft's power will bring the generator at the other end to a dead stop, which will tear it out of the floor to which it is fixed, and quite possibly tear through the roof of the building.

Time to start the craft's generator up. This is connected to an outside source, in our case a small diesel engine. A minute passes by and the cutout switch of the craft breaks the contact with the outside power source. We commence to accelerate the craft's generator. Now she is on her own. I grab my camera to see if I can get a shot of this. I set the speed to 1/500th sec. Aperture is fully open. Just saw two people walking in the direction of the launch. Another grabs his camera with black and white film. He concentrates on what these two are going to do when they realize what is happening. When the generator started there was a whine rising to a high pitch, but that is now stopped.



1500 hrs.!! Is it going to lift? My heart is hurting me, throbbing so severely that I can see the beats as I take a quick look down my very wet tee-shirt. My veins in my legs are swelling and painful, and my hands, the veins are large and dripping in sweat. My hair is dripping down my nose. Yes, the craft is shooting up very fast,— got a job to get it in my viewfinder. There it is! I shoot, turn the film over.

All our team with cameras are doing the same as fast as we can shoot and turn the film. Yes, the craft will clear the power lines with no trouble. I have now stopped taking photos to record what I saw as I looked through the view finder. I saw the ground appeared to be rocking, yet I could not sense any such rocking. The pylon behind the craft seems to be flying apart outwards and upwards. I shot my glance over the far side where the two strangers were. What happened to them? To me they looked like two poles stuck in the ground, but in fact they were running for cover in the direction from which they had come,—most likely scared stiff. Then the call came in: "She's crossing Cornwall now. Time 1503 hrs. G.M.T."

We all relaxed except my heart which just would not stop that mad thumping. Our team in Cornwall turned the craft for its run back. We went over to the launch point and found that all the small undergrowth had been pulled up with the soil and had left a scooped-out effect where the craft had stood. There was burnt ring around, and the undergrowth meeting this point was laying backwards to the bare section. One thing is now a problem that we must try and solve; that is this pulling out of the earth on lift off and this burnt ring mark effect.

P-11 did do many flights from the period of August 1968 until December 1968 when she was destroyed, as there was no place to house it for safety's sake. The P-11 would fill a book on its own. You might say that the P-11 is dead. She has been laid to rest in the records of the success story of Starship Ezekiel, and was only a small bit of that story. We learned a lot from P-11, but Demo 1 has taught us even more, and is not yet complete. How much more will Demo 1 teach us when she's shot up into the blue sky! This time a mass of cameras will record her launch by slides and photos, cine films, and even TV cameras for the world to see.

In a later comment about the P-11 Mr. Searl said, "Of the thirty-nine crafts flown, probably the most interesting was the P-11. This was launched on June 30,1968, and crossed Cornwall in three minutes. This craft then went on to orbit the Earth five hundred times, giving us a great deal of information which has greatly influenced our present and future plans."

DEMO 1

J.T.- How big was DEMO 1 ?

J.S.- Twenty-one foot diameter and Weighed about 12 tons when it was finished. It was covered with a clear plastic so people could see that there was no trickery inside. And the cameras could see thru it.

J.T.- And it would fly even with the clear plastic on it? I thought you had to charge it on the top and bottom.

J.S.- Of course we ran a fine wire grid to act as the electrical doings. But the plastic had a negative charge. It was selected for this particular work.

J.T.-I see. So then you ran a thin grid of wire in it to charge up the top and the bottom?

J.S.- Charge up the surface. Then you have the flight cells at the edge, so you could control the movement of the craft.

J.T.- So that was capable of flight.

J.S.- Oh yes! It sure was. It could go around the world as many times as we wished! It's main objective was to prove to the scientists that such a structure could support itself. And they were wrong by saying it couldn't. And I proved my point.

J.T.- How far did you get that one off the ground?

J.S.- Well, we had it up 12 or 15 miles. Whipped it around at 1000 miles per hour and brought it down and put it down as though it was no problem.

J.T.- Did the DEMO-1 still have the SEG in it when you left it?

J.S.- Yes, it was all complete when I left it. I was wiring it when Bill Sherwood came with his wife Rhoda and Dr. Kane. We were well into the wiring of it. We had it all complete.

J.T.- Oh, so did you have the SEG running all the time?

J.S.- Yes, it was running but we could stop it because when I was in Canada I found out by accident how to stop it. Up till then we didn't know how to stop it. We could never stop the engine once it started. But while I was demonstrating it in Canada, I was demonstrating it on T.V. I forget what the station was now. I'm still trying to find the copy of the report on it. The original was destroyed. It names all the people who came to the demonstration. Of course millions more saw it through TV. It was seen right through to Washington. In the middle of that demonstration, it stopped. For the first time ever. It stopped. And of course my face was such a shock that the cameras pulled back to look at my face! And as soon as they did that, off it went again. And immediately when that happened, I knew why. The oscillator of that camera was beating an artificial pole on that bar. And it stopped the roller because it could line up with two poles. But as soon as that camera was gone, that pole was gone, and away went the roller again because the poles are unbalanced. So I knew the answer. A simple embarrassment produced the answer.

## U.S. DEMONSTRATION OF FLYING CRAFT

**J.T.-** Didn't you demonstrate the flying disc to the United States Airforce a long time ago?

**J.S.-** Yes, that was at your Edward's Airforce Base. I used to have the letter from them that said that the technology was outside their accepted technology. That was one problem. Because they said, "Your craft doesn't appear to have inertia. That is contrary to all our knowledge." This was around 1970. And the next thing they said was the speed and the turns were so sharp they doubted anyone could survive. And funny enough, that's exactly is what Freddy Laker said, and British Airways said, but they're stupid! Because I tried to explain to them, "You are traveling a damn sight faster right now while you're standing here talking to me! And you're not feeling a bit of it! So if that craft is exactly like this earth, it is a world of its own. When you are in it, you are related to that craft and not to anything else.

**J.T.-** Who was the officer there?

**J.S.-** It was one of the top scientists there of the flight research department. I'm annoyed that all of those papers are lost. It may be in one of the old Journals. I think there were two problems with them. I think the major problem was, they couldn't believe anyone could live inside a craft at that speed making those turns. That was the major thing. And the second major thing was they couldn't explain why there was no inertia. If they could solve an answer for that, they would have probably took it on.

**J.T.-**I think it was way over their heads.

**J.S.-** Way over their heads! They are born with the fact that everything has inertia. When you apply force, it takes time for the force to begin to move. It has to overcome this resistance. But this, these rollers immediately move and are traveling instantly at a constant speed. Now that is against everything they know. And to take a job on that does that, that they cannot explain that phenomenon, they would look stupid! And the last thing that they will do is to take on anything that will make them look stupid. And that's what it boils down to.

## FLYING CRAFT SIZE & USES

J.T.- What were the sizes of the flying crafts you made?

J.S.- The biggest one was forty feet. We had two at thirty eight feet also. But the one we allowed the media to watch us build, DEMO 1, was twenty one feet in diameter.

J.T.- How big was the one in the picture, in flight?

J.S.- The one in flight. That one was twenty one feet.

J.T.- Oh, I thought it was smaller!

J.S.- No, it's just because of the distance away.

J.T.- Do you have to stay a long way away from it?

J.S.- Yes, quite some ways from it. The way they took the picture gives the impression that I'm really quite close to it. But that's done really, I think, to try to emphasize to people that it's quite safe in the air even if it's just hovering there.

J.T.- What if you brought that down close to say an automobile or something? Could you bring it close to another object?

J.S.- Oh yes. If you brought it say to a car, you know quite naturally that no one is in it, you could lift the car. You wouldn't lift it with people in it because there'd probably be no oxygen in the car.

J.T.-I see, the field will go around the automobile?

J.S.- Yes it will go around, you can lift the car. The car will cease to have weight. You wouldn't lift it with people in it because they would have no pressure suit on or oxygen supply.

J.T.- O.K. I thought the field would repel everything outside of it.

## Chapter 4

J.S.- No. Only if something was heading towards it. If you came over the top of it, then it doesn't because you've got solid mass holding it from pushing away. Once it's in the vacuum it would be sucked in. But something coming at you like a rocket, it would be twisted away and deflected. It would slowly deflect and by the time it was in line at the rim, it would be turning off by something like forty five degrees away from it.

J.T.- Oh, that's a nice feature!

J.S.- Yes, it turns away and takes an entirely different route. Just one thing has to be brought to mind, if your racing in a space ship into space and a great chunk of rock is coming towards you, the craft has to sum up whichever object has higher kinetic energy. Whether the oncoming object has higher kinetic energy than the craft has. If it has then the craft has to move out of the way. But if it's energy is greater than the energy of the rock then the rock will move out of the way. It will be deflected.

J.T.- Well either way you don't hit it. That's good!

J.S.- We used to rush models towards my home to show that it can't hit the building. As soon as it gets close to the building, the field pushes it away.

J.T.- Were there ever any manned flights of your crafts?

J.S.- No. None were manned. Because of the vacuum created by the machine, it would make life support systems necessary and the cost was too much. There were 6 crafts lost before the radio controlled P-11 was flown.

J.T.- You had two units, 21 and 22. Were they both in orbit for two years?

J.S.- Oh yes! Most of the crafts were really up there 10 years before we got rid of them.

J.T.- You had some up there for 10 years??

J.S.- Yes. Of course once they had done what we wanted to know we can't really do anything else with them unless we were going to expose them. And we couldn't do that until we had enough information that would allow us to man one. You see media are, shall we say, ignorant people, technologically. When they see something going on, they can't see why you can't man them. And if you can't man them, they start giving you bad publicity. And cause governments to stamp down on you.

J.T.-I thought the longest ones in space were 2 years.

J.S.- Oh No!! Most of the crafts you can say were credited with a good ten years of flight time. The two we talk about for 2 years were testing basically the new nylon body material which went into strychnine. And we had to discontinue this fiberglass material of those days.

J.T.- That was 21 and 22. But all the others stayed up a long time also?

J.S.- Well, all the other 40, only two of them ran into trouble and produced strychnine and thus only did two years of time. But what the others did was shown. We took many photographs. We were taking photographs here, there and everywhere! We brought the crafts back and had the film developed and we had cine films.

J.T.- Did you have them right in orbit or...

J.S.- Yes, from the orbit. I knew more about Australia than any book ever told me! When I wrote to a chap in Australia who thought he knew a lot and started telling him some facts and figures that I knew, he was surprised! He wrote back and said, "I was surprised! I had to go and look for myself! I didn't know." He said, "You're right. How did you know? Have you been here?" I wrote back and said, "No I've never been there."

J.T.- Drove by!!!

J.S.- Yes, but I said, "You can't tell me much about it. I remember a lot from what I saw in the films. You can't kid us about it. I can tell you all the radio points we used to keep ourselves on course." So I knew where the vehicle was. But I said, "The day will come when I'll be back in the field again. Only this time we'll be manned."

## PUBLICITY

**J.T.-** Was there a lot of publicity for your work?

J.S.- We do know is that the BBC has a lot of film. Because they came out every month to continue the story on the work. Now, do you know any other individual that had a regular program on all channels in the U.K. that's 4 channels. Monday in the first week of the month the BBC 1 carried on with the story where they left off. They would show you just a little bit of the story from where they left off. They'd show you just a little bit of the story in a flashback and then carried on the story as to how much progress had been made over the month.

The following week ITV, an independent TV program, came along and did theirs. They'd take you back to what they last showed you, bits of it to bring your mind back to what you've seen, and then they would continue the story as to how the progress had gone. And we had been doing this for a whole year!! In there, there was some flight shots showing the craft going up through the trees into airborne and they played the music to the movie 2001 to it. They played me against the Americans effort. All the American failures were kind of chipped and worked in to make it a good comical game, but that was perhaps the bad part about it. It might make people laugh at American failures and we're racing away with a complete new technology. They were playing on this and of course when you eventually went to the moon, we were only 3 months away from proceeding with a manned flight.



**PATENT TAKEN OUT**

J.T.- Didn't you say you took a patent out?

J.S.- Well we took out a provisional patent. But when we discovered that for a shilling you could go and get a copy of the papers that cost us POUNDS. It cost us a fortune to put in, another person would only have to pay a shilling to get a copy of it. And to me, that seems suicidal.

J.T.- Well did you ever put patents in?

J.S.- We just let the provisional die out. But of course things are going to change now. Because when the work is finished, and we've gone into production stage, we're taking out the patents in Europe, America and Japan to start with.

## EXPLOSION

J.T.-I was just looking at your lecture again and you said you were in an explosion. Was that when you were building one of these?

J.S.- Yes, Well the explosion was not really my fault. It was somebody else's fault. They put a 10 gallon drum of oil on top of a hot plate that was on. They switched the wrong plates on, and the twins, our twins, got up in the corner at the back of the boiler where they were playing. And I was wondering how the pot of oil I had on was warming, getting hot enough for a job I wanted to do. And when I got there I was amazed. This tank was red hot. It actually was red. The metal was red hot. The kids were playing there. I had to rush and pull them out of the way and told them to get outside as far as they can out up the garden and I rushed the doors open and the windows open and then I went to lift the tank to bring it outside. So if it was going to blow, it wouldn't damage the house. But just as I was walking past an open window to get to the door, a draft of air caught it and it went like a bomb. It took all the paint off right through to the bricks, about 10 layers of paint. It took the ceiling off. It disintegrated the lamp shade and cables. It disintegrated the fuse box and disintegrated the electric meter. It ripped everything out! It stripped the whole building down to bare bricks.

J.T.- It's amazing you weren't killed!

J.S.- Yes, and the clothes hanging on the line drying all went, line-lot, everything disappeared. My hair was on fire. Nobody moved to do anything to help! We had a big chest freezer, so I had to dive into that. And all my neck was burnt, blood was pouring out the jugular vein and I had to strap myself. And nobody would ring the doctor. I had to ring the doctor myself. They dressed me all up but 24 hours later. I was in real agony. I had to be rushed to the hospital and gangrene was forming in my neck.

J.T.- Oh no.

J.S.-And you could see the blood gush out as they took the dressing off. They said the doctor put the wrong stuff on. He shouldn't have used that type of dressing. So they had to pump penicillin into me and dressed me up. I looked like an Egyptian mummy! It was for about 8 weeks and then the Sherwoods, (Bill and Rhoda) arrived and Dr. Cain arrived. I was just undressed apart from the neck. The neck still presenting a bit of a problem. That was covered. The doctors at the hospital said that my face would be permanently marked, but the Sherwoods were shocked when my face had been just uncovered. I think when I arrived at this place I was still dressed rather up, a bit like a mummy, when I arrived at the hotel to meet them when they arrived. But in the

week the dressing had come off, except the neck. That was still pretty bad. The Sherwoods and Dr. Cain were very surprised how clear my face was. That showed you the power of this machine. Without that machine my face would be permanently marked.

J.T.- So you had the machine running in your home.

J.S.- Yes, in the house. It was feeding most of the electric in the house for us. And of course it was purifying the room. Killing germs, everything. So my skin had a chance to heal.

J.T.- So where was your wife? Why didn't she call the hospital?

J.S.- WELL- She didn't do nothing. She just walked over you if you laid on the floor ill. She just stamped on you and walked by.

J.T.- Well that's too bad....you could have been dead!

J.S.- As far as she went, you were there to supply the money for all her needs. That was your job. That was all you were there for. All this other stuff had nothing to do with her. She wasn't interested and it annoyed her.

J.T.- What about your children? Have you kept in contact with them?

J.S.- No. Because she turned them into antisocial creatures towards me because she resented this work.

## USES FOR SEG

J.S.- We show clearly that we can produce straight flat bed, straight line generators if that was more convenient. And this would be ideal for propelling trains. And if we built it into our road system we could have cars running on that sort of system. But then you see if we want to maintain the present road system, we can turn the wheels into SEG's.

J.T.- Right, or just use the SEG for a generator and run an electric motor.

J.S.- Yes with just one SEG. The options depend on the capability of your own brain to imagine how you can apply it.

J.T.- It's just a matter of getting the first ones out now.

J.S.- Yes, it's been a long time, agreed, but then you see the problem in the past was we wanted big money. Everything in MY line of interest, that's energy, seemed like the government was going to produce cheaper and cheaper. So why bother to take interest in an entirely new concept. And have to relearn everything from the beginning when what was coming up, nuclear power, was going to become free energy. Plenty of it. No problem in a subject that was pretty well understood. So all they were doing was changing coal boilers or oil burners to nuclear.

J.T.- Well they didn't go to far did they?

J.S.- Things didn't turn out quite as they were forecast.

# CHAPTER 5

*This chapter will deal with the SEARL NATIONAL SPACE RESEARCH CON-SORTIUM and the destruction of all of John's work.*

This segment is taken from the SEARL NATIONAL SPACE RESEARCH CON-SORTIUM newsletter of September 1, 1971. In it John Searl gives his views and projections for the future.

April 1961 saw the first manned spacecraft launched from Baikonur in central Asia. It was then followed by the first American one, launched from Cape Kennedy. Such is the pace of space progress, that today many different types of spacecraft exist, or are under development. I know that, when this statement is made by others, the Levity Disc is generally not included. Why not? It, too, is a construction of a space program. It's merits exceed those of the rocket by far, and I say this with no disrespect to the rocket designers. Why, then, should it not be included among spacecraft under development? Is it simply that America has already made a number of manned flights to the moon? To that type of argument, I say, (if you will excuse the term), "Rubbish!" You are comparing one man's progress against the mighty resources of finance and manpower available to the governments of those countries involved in space work.

Remember also that nearly twenty years was spent on costly research before they succeeded in their achievement. By contrast, I have spent only three and a half years on Space Project Swallow, much of the work being done in spare time or in time stolen from normal sleeping hours, and all of the financing coming out of my own pocket, or from the support of a few interested friends. So if you wish to compare hours times manpower times finance, I have, (you might say), thousands of years to go before I catch up to the amount already spent by the Americans! I am sure that long before then, we shall have visited the moon, Mars, Venus, and all the planets of our solar system, and will have launched exploratory craft deep into the Milky Way Galaxy, outstripping the American and Russian rocket system completely. I say this in absolute faith.

Man stands at the threshold of fantastic new explorations deep into interplanetary space. Only now has it been possible to assess the achievement of man in space, and in our newsletters the facts of both the Russian and American space achievements will be given, as well as our own progress so far.

You may have read many of the current articles in books, journals, etc., on the subject of space, or have received programs and interviews on radio and TV. I too have had programs on radio and TV, as well as press write-ups. However, these have too often been presented from a humorous rather than a serious point of view, which of course has been more of a hindrance to our work than a help. Some have been critical of the estimated costs of our project. May I say that the cost of the development of the Levity Disc will be only a fraction of the cost of one Saturn Rocket.

The money spent on the advancement of knowledge through research is seldom wasted. Given time, the investment nearly always reaps a rich reward, often in the most unexpected direction. Astronautics, the science and technology of space flight, is likely to be no exception. Especially is this so in the case of the Levity Disc, since its constructional and operational costs are so small compared to those of the rocket system.

Combining as it does almost every scientific and technical discipline, space progress has already become a "spearhead technology", stimulating the development of new materials and processes of manufacture. The benefits will most certainly accrue to the Levity Disc in terms both of time and expense. Space progress may be expected to produce a steady advancement in such basic fields as metals, ceramics, plastics, microelectronics, power generation, industrial management, and many more. The effects on industry in general are revolutionary and to a large extent unforeseeable, but they may be expected to have the widest significance for twentieth-century man.

Space progress will also produce important medical benefits. The close attention now being paid to the workings of the human body under space conditions is resulting in the collection of more data on vital physiological functions, particularly in the reaction of the circulatory system to stress, than in decades of conventional medicine.

Techniques learned in space, such as monitoring bodily functions, (heart-rate, respiration, etc.) by telemetric sensors, are directly applicable to the work that we will be doing in the development of the Levity Disc. These developments are revolutionizing medical instrumentation in hospitals, and we intend to make full use of them on Starship Ezekiel. Thus she will be virtually a semi-automated space hospital, where a patient's physiological reactions are automatically reported to master consoles, which in turn telemeter the information back to consoles on planet Earth, which both alert the medical staff and provide computerized data on the patient's condition.

However, new and perhaps even more exciting opportunities are about to open up. Medical research could benefit from the close attention that space scientists are paying to the living cell in probing for the essential conditions for life to develop on other planets. What most people do not appreciate is the fact that the space effort presents man with a golden opportunity to open his mind up from a narrow path to a much broader path, so that he can understand more about himself and his total environment. Nothing before ever so stimulated man to dig deeply for new knowledge as the prospect of the actual exploration of space, which first appeared about twenty years ago.

The automated biological laboratory which the American Voyager spacecraft is to land on Mars in the 1970's will have both soil sampling and air sampling apparatus for checking on the presence of bacteria and reporting findings to Earth. Equipment which will be used by Starship Ezekiel to do work of this type will be constructed more quickly and cheaply as a consequence.

In this area of advanced biology, the interests of space science and medical research may merge, to the benefit of mankind- for a greater understanding of the properties of the living cell is fundamental to winning the battle against malignant disease. It is interesting and vitally significant that important experiments concerning the structure of living matter are now taking place in research centers devoted to space problems.

If these are some of the "hidden" benefits of space research, there are others more obvious, that are almost taken for granted. One is the relay satellite, which allows television to span continents and oceans.

We in England watched Apollo 15 on television transmitted from America. The pictures were extremely good in quality, when you consider that they had traveled from the moon via America to us. I was unable to see much of this transmission because I was too busy working on the construction of Demonstration Craft No. 1 at that time, but I did see the bit about the Hadley Rille. I might comment that I was rather disappointed. A lot was said about what we were going to see, but when the time came, nothing at all showed up to tell the difference between the surface and the rille itself. As far as I could tell, it was almost as level as the ground the astronauts were walking on. Aside from this, the pictures were very good.

I did see the lift off from the Moon's surface, and to me that was well within what I expected to see. Many expected to see large gusts of flames, but I had already calculated a different picture, which looked more like what we saw. There were a few things which spoiled the whole effort to some extent. These were not necessarily the fault of the astronauts, but of those who planned the program they were to accomplish and the tools which they were given to use. We will take this up in another letter, in which we discuss how we plan to conduct experiments on the lunar surface.

The development of satellite communications in the first decade of the space age has been a little short of miraculous. When we see programs on our television screens relayed across the Atlantic, we think of the small box of high-grade electronics working unattended in the hostile environment of space that makes it all possible. Very few people could have imagined the standards of reliability now being achieved in space electronics. Yet during 1952 I had stated that a crystal-type solid state component would be developed which would make space travel possible, even if the tube could not perform its functions with reliability over a long time, or withstand the environment.

The achievement, of course, extends far beyond communications. As an example, satellites warning of the approach of hurricanes and typhoons, as well as performing routine global weather survey, are in regular operation. And the future is bright, for the combination of these systems in the form of multipurpose spacecraft such as the Levity Disc should cut the cost to a small fraction of today's rocket costs, thus enabling man to devote more of his energies towards serving his fellow man and protecting him from death and destruction in the wake of natural disasters.

If so much progress has been achieved in the last twenty years, using only rocket systems, then what will happen in the next twenty or thirty years if the Levity Disc were developed to replace the rocket? It is not difficult to predict that our planet will be covered by networks of space communication satellites serving the interests of government, trade and industry. Computer-controlled information banks, flashing the most up-to-date data of all kinds by satellite to all subscribers around the world, have already been suggested. Again, the Levity Disc is ideal for implementing such a program, offering rich opportunities for commerce and education.

One other important development has been accomplished. This is the direct-broadcasting satellite poised in geostationary orbit, beaming radio and television signals directly to control centers, and in the foreseeable future, to home antennas. Such powerful satellites, dispensing with costly ground terminals and cross-country relay stations, will depend on inexpensively produced dish-antennas pointed skyward to



intercept the signals coming to them directly from space. In this way programs beamed to a satellite from a single ground transmitter will be retransmitted over a vast area. Apart from the utility of such satellites in developed parts of the world, consider their effectiveness for bringing education to community centers in emerging countries.

The growth of supersonic air travel, first over the Atlantic and then the Pacific, is also likely to depend heavily on satellites for air traffic control, in order to assure maximum safety for the international commuter. This will be increasingly true as Levity Discs become the accepted means of high speed travel across the face of the globe, and as the benefits of the economy of this mode of transportation are increasingly realized.

None of these techniques demand radical advances from systems already developed in the first space decade, and their influence is likely to be much wider than we can imagine at present. But even this is not the limit of the space age potential. Those who strive to build the science of the space age, astronautics, (and we are certainly doing our share to interest others at a high business level), whatever their country, being filled with a desire to promote a deeper understanding of the universe through interplanetary exploration, have always regarded ourselves as members of a greater international family. It is therefore heartening that space activity, rather than adding to the human burden in terms of armaments, will actually tend to reduce international tensions and promote cooperation.

In a very real sense, space travel is sweeping aside national boundaries, making closed societies more difficult and breaking down international distrust. Eventually the space race that grew out of the East-West rivalries of the fifties must give way to collaboration. When it does, it may well bring about the climate for at least a degree of disarmament.

Already the United Nations Treaty on Outer Space, signed in 1967 by countries of both East and West, bans weapons of mass destruction from outer space and provides for equal access to the moon and other celestial bodies by all nations. (In regard to this treaty, I would like to make the comment that, although not a signator, we will undertake to honor all that is good within the treaty, and intend to make a full statement as to what we agree to, as soon as we have an opportunity to study it thoroughly.) Out of this could grow collaboration in the exploration of the moon. When it becomes technically possible, in principle there is nothing to prevent the countries of the world, under an agreed program, from combining in a joint logistics operation to carry prefabricated parts to the moon, (or to any planet), for the development of an international lunar base.

We heartily concur with a statement made by the late President Kennedy before the U.N. General Assembly on September 20, 1963. He said: "Why...should man's first flight to the moon be a matter of international competition? Why should the United States and the Soviet Union, in preparing such expeditions, become involved in immense duplications of research?"...But I am afraid this is exactly what has happened. In our case, we are traveling on an entirely different road. Whereas they have duplicated much construction and expenditure, I state that surely we should explore the possibilities of cooperative effort on the part of scientists and astronauts of all countries, so that we might someday send to the Moon, not the representatives of a

single nation, but the representatives of planet Earth. This is our approach. Those who make the first journey on Starship Ezekiel will be listed in our records as representatives of the human race.

We urge others working on some radically new approach to space travel to join with us. Individual effort, however laudable, can never be as effective as cooperative effort. Alone, you will not achieve much, but a collaborated attack on many different ideas will yield results more quickly and cheaply, and avoid wasteful duplication. That is why we are progressing so well. United under one center that directs the fields of study, we pool all results back to the center, where it is arranged into systems.

Why is it that the suggestion of international cooperation in space development still lacks a formula for combining the resources of both East and West, yet expresses the feelings of so many people? In Space Project Swallow, everything possible is done to maintain an ease of approach to joining, and to encourage the different countries to produce a sub-journal to translate our work back to their people. And the pooling of information is working very well indeed. At some future stage, in an atmosphere of reduced international tensions, it may be possible to achieve a degree of technological cooperation. Possibly the best chances lie in the direction of expensive projects involving logistics supply, the lunar base, and manned interplanetary exploration.

As a first step, it might be possible to develop an international orbiting laboratory. This would involve not the assembly of a single space station in earth-orbit, but rather the orbital grouping of a number of spacecraft in conjunction with a "dormitory" module.

The various components, put up from launch centers throughout the world, would serve different functions. For example, one could work in astronomy, one in biology, and another in meteorology and Earth conservation. Each would benefit from the others in terms of logistics support, equipment repair and astronaut safety. This is how we planned our efforts.

The first Starship Ezekiel will be an all-round basic research and study craft, mapping the basic facts. These, in turn, are telemetered back to Earth. Next, another craft is designed and constructed on the findings of Starship Ezekiel, which in turn moves on to another mission, (possibly an unexplored planetary surface), again telemetering basic information back to Earth. If the second craft is capable of handling all the work it will have to do, no other will be needed. If not, another craft will be designed to cover the fields which the second craft could not. Thus the craft arriving on a planetary surface will be equipped only to cover the basic findings of Starship Ezekiel, in order to complete a comprehensive scientific report. Time and money will thereby be conserved to the fullest extent.

Astronaut-scientists would move between the different vehicles in a kind of "space-taxi", which would be a Levity Disc of the Searl system, using a docking technique. Such methods have already been seen in the Gemini and Apollo programs of America. At a later date we shall study modular assembly of an orbiting laboratory.

The prospects for this type of development are considerable, for scientific satellites and space probes could be placed into position by Levity Discs at a price that could not be equalled by the rocket, which has already begun to revolutionize our understanding of the universe.

Cameras and spectral sensors turned towards the Earth have shown the promise of new opportunities for assessing the world's natural resources. The National

Aeronautics and Space Administration has defined more than 200 Earth-related experiments that could be performed from a manned orbiting laboratory, including cartography, (mapping), geology, oceanography, water management, ice survey, agriculture, meteorology, and other studies unique to the space environment. All this could be undertaken by specially designed Levity Discs, economically and efficiently.

Dr. Wernher Von Braun, technical director of the Marshall Spaceflight Center in Huntsville, Alabama, U.S.A., has written enthusiastically about these prospects, I am told.

Wherever man goes, he cuts trees, tills soil, builds houses, factories and roads. All this diverse activity is detectable from space. As information collated with Earth-based information, it can be used to assess the world's burgeoning population and their future needs. From the vantage point of space, it should be possible to detect crop disease in time to initiate corrective action. Black stain rust, for instance, is difficult to detect in its early stages. Remote sensors can spot the rust several days earlier than a man who is standing on the ground. This is an example of one of the major areas of work where space development will make a contribution.

Using similar remote sensing techniques, it should be possible to discover water and mineral imbalance in the soil, leading to better use of land in agriculture. By measuring minute differences in soil temperature, it may be possible to detect underground rivers, or measure snowfall and spring thaws helpful to the management of water in storage lakes. Life patterns in the seas and feeding grounds for fish may also be discernible.

Let me assure you of this: man's future on this planet will depend on how well he learns to use the planet for his ends. Otherwise the planet will see man's end, and sooner than most of us are able to appreciate. Many of these remote sensing techniques are possible because of the prior development of military reconnaissance surveillance satellites. Observations made by the astronauts themselves have contributed important information.

Will such craft as Starship Ezekiel be restricted to one country? My answer is "no". Nor do I think that only the rich countries of the Earth will do research with these craft. I can envision grants being established on the pattern of Antarctic exploration, whereby graduate scientists of all countries could qualify after special training, to conduct research aboard a space vehicle like Starship Ezekiel.

Whether or not this degree of cooperation comes about after the "space race" is over, only time will tell. At least we at the National Space Research Consortium have made a start towards it. Whether it will catch on or not is up to you.

I make this offer to you in good faith: join with us now and we will pull together to speed the success of Space Project Swallow. I truly believe that, despite differences in ideology, the nations of the world can work together in cooperation, not competition, on the routine and arduous task of exploring space and the planets for scientific and economic purposes. If so, then the best hopes of those who laid the foundations of astronautics will have been realized.

Mr. J.R.R. Searl, M. ins. P.I.  
Director of Contracts, U.K.  
Space Project Swallow

## THUMPED BY THE POWER COMPANY & HOW SEG WORKS

J.T.- Now when you were talking to me before you said that when you had a problem with the electric board and they came and arrested you, you said that they were made because you "thumped" them. What did you mean by that?

J.S.- Oh, that's an article in the latest book, where it told about when the electric board removed all our power. Back then we moved from the Midlands down to Berkshire and while I was up there at their headquarters I purchased all the switch gear and cable and the cooker and things because I knew the house we were going to had no electricity. So I wired up the place and when that electric board came to connect the power they said they wouldn't connect it because the switch gear did not comply to their requirements. And I was REALLY angry because it was all the electric boards property that I had purchased, and they were refusing to connect it because I hadn't bought it from THEIR show room. So when they refused, I connected it.

After three months they came and took the power off. So I went down and told them. I said, "You've got exactly 24 hours to put that power back on, or I will stop all power for the whole area! And it will keep off until you put the power cables back!" And they said to me that I can't take the law into my own hands. I said, "You just try me and see! I have the technology and I'll USE it!" By the time I got back, the cables were back on. So they realized that I meant business.

J.T.- When they finally let you out of jail, did they give you any money? Did you sue them?

J.S.- No. No. I had no home or anywhere to go to. Nothing. The home was gone... everything.

J.T.- What did they charge you with?

J.S.- Well I had built and installed an SEG to supply my home with electricity. They charged me with stealing electricity. They called it stealing electricity because, electricity was supplied to your house and you weren't using it. But you had electricity. But you were supposed to be using THEIR electricity. But today, I assume, that if you put up a power generator of any kind, you could ask them to take off their electric. But you couldn't in the time we're talking about. You had to use their electricity if it was there. You couldn't use your own. It was forbidden.

A man by the name of Devon E. Tassen said to me when I was there with him, that he came to Scotland and put in a water generator, a power generator, and he had a hell of time. They broke him! He had to do this, he had to do that. The electric board fought him. He said we've fit these everywhere, with no trouble. But in England they were really making sure that we didn't make a penny's profit out of it. They made us do this and made us do that. Things that weren't needed. But you had to do it in order to be able to do the contract.

J.T.- So they came and told you, you were stealing their electricity even though you were generating it with your own SEG.

J.S.- Yes, because you had to use their electric. They were "all powerful."

J.T.- On that SEG that you had running your house, what was the output?

J.S.- That was a very old SEG. I made that back in 1952.

J.T.- Oh, did you make the coils so that they put out the exact right voltage?

J.S.- Yes, 240 volts A.C. and up to 11 kilowatts.

J.T.- Oh, alright, so you didn't have to transform it or anything?

J.S.- No. No. I set it into the wall as part of the wall structure. And just brought the power up to the fuse box and from then on it was just normal house wiring.

J.T.- Now did your voltage stay constant even when the load changed?

J.S.- Oh Yes! It makes no difference. Because, you see, is as soon as there's a larger current, the rollers run faster, and the machine goes cooler, so the power is improved.

J.T.- You would think that it would cause your voltage to go up.

J.S.- No, What happens is that your coils are really your resistance block. But remember, as the coils get colder, there is less resistance. So more current is available.

J.T.- Oh, so you're just drawing more current without a voltage rise.

J.S.- Yes, because you're going into a superconductive state. And as you take more and more current, the nearer you are getting to the superconductor state. But it's when you get to the superconductor state, is when you get into trouble! Because it goes airborne. So you know you've got the superconductive state.

J.T.- Ya, you know you've got it then!

J.S.- Yes, but at the time we didn't realize what was happening. It just shot off into the air! We know now that the reaction of a superconductive state will pull away from a magnetic field. It will lift away from it. The earth is a magnetic field, so the object is going to go away from the earth.

## DESTRUCTION OF A LIFETIMES WORK

*I asked John what his wife thought of all the publicity.*

J.S.- At this time we were very close to a manned flight. And then when the wife realized that I was going to win. The newspapers were telling her that "The next time we come he'll be Sir John." And she didn't like that!

J.T.- She didn't?!

J.S.- Oh, no! She planned then that she would do something to stop all this work, and stop it for good.

J.T.- Gee, You'd think she would like that!

J.S.- Oh she got everything destroyed, legally. 5 million pounds of property. The public's money. And on top of that a lot of people had been very nice to her. Bill Sherwood and his wife Rhoda brought presents to her and the children. Dr. Kane had her hair all done up and paid for it. He bought me shoes because he knew I wouldn't buy any and my feet were out of the shoes I had. He told Rev. George Nicholson, "Take this money and get him shoes because if I give it to him he'll put it on the spacecraft." The Japanese that came by the hundreds all brought presents. Not one of them came without a present. So it wasn't that she was hard done by this thing, she wasn't. And I think Bill will tell you if you ask him, that the children and the wife didn't suffer. We were hard up, yes. Because I was working nights to keep us going and working days to get the work done. And that was hard work.

J.T.- How did she manage to get your work destroyed?

J.S.- Well she got together with the power company and they arrested me on the charge that I was stealing power from them. You see I was running my house on an SEG and was not using their power. The police and the power company people ripped out all the wiring in the house and confiscated the SEG. I was unjustly thrown into prison and while I was imprisoned she called the police and asked if she could get rid of all my papers and equipment? They said that she could do whatever she wanted as she was my wife, the things could be considered hers also.

There were also books kept by John at his house of all the people who had witnessed his work. Each person would sign the book and put down their thoughts. Gunner Sandberg was asked to go to John's home while he was imprisoned and get those books. He went to the house but did not get the books. He was sent to get certain information from the house. One of the things he was asked to get was the book that was signed by everyone of the people who witnessed the demonstrations of the SEG and levity discs. He said that there was too much there and he was going to go back for it later. Meanwhile the authorities burned all the papers in John's home. Witnesses said it took 4 days to burn all the material. His equipment was also either destroyed or sold off. This was sanctioned by John's wife.

J.T.- Was everything destroyed?

J.S.- Yes, and that was written off in four days, the bulk of that proof was destroyed in four days by four days of continuous fire. That is what I was told by the fire brigade. I was told by an American that called. He wrote to me and said, "I called on your home and found big fires burning. They're burning all your stuff!!" And I said, "No you've got the wrong place." And then another chap wrote me. Ivor James Powell wrote me and said, "I went to your home and they're burning everything!! All your records, films, everything. Photos, all being burned!" I wrote back and said, "You must have made a mistake! You must have gone to the wrong house!" But they were right! I understand from the fire brigade that they stood by for four days while the fires burnt.

*This section is in reference to an interview with a magazine reporter.*

J.S.- Now he asked where my family lived. My family has nothing to do with me. They were my pain in the ass. They prevented me from reaching my success. They did everything to stop it and they got legal law to destroy everything. Now, they then tried to sue me for their keep. When it was all over I refused. I just simply refused. I would not pay a penny to them. They kept me out. They destroyed my life. They destroyed everything I stood for and just at the point that I was reaching a success. I didn't know where they were living myself so I couldn't tell him. I didn't know because they had moved. When I came out of prison they were gone. The home was gone. Everything was gone. And I had to walk to the Midlands and try to find a friend to take me in. Because I had nothing.

CHAPTER 6  
*The Long Road Back*



## MEETING SUSAN

J.T.- Well, when did you meet Susan? After you got out of prison?

J.S.- No, later while I was in the Midlands. Well, what happened was Luis Jarillo was advertising for me in the papers and magazines for accommodations, preferably in the London area. The idea was that if I came to London, he could help me to try to recover the past information and rebuild again. And that was supposed to have been the reason.

J.T.- That was after you got out of prison and were looking for a place.

J.S.- Yes, But I met lot's of people from all parts of the world. They were all divorcees, they just wanted a good time and therefore I wasn't compatible. And in the end Luis rung me to say that there was a girl who rung up that said she worked nights. And she sleeps during the day until about 4 o'clock or 5. And if I'd like to ring her, she'd like to tell me something about herself. If I'm interested I could come down to meet her. So Luis gave me her number.

So I rang her and she said, "Well, you can come down and see me." Oh, first she said, "I'm black, do you mind?" I said, "Well have you got a heart?" I said, "That is the important thing. I've had a wife with no heart. And I want somebody with a heart." And she said, "Yes." So I came down and stayed the night with Luis, and we both came down late in the afternoon to meet her here. And I stayed. She asked me if I wanted to stay and I stayed. And that was on a Saturday and on Sunday I went back.

On Monday, a week later I paid for her to come up to me in the Midlands and she stayed the weekend. And then I came down here again and took her down to the coast for the weekend and came back. And she came 2 more times to the Midlands and I said, "Well if you're prepared, I'll move in with you and bring some of my stuff down." But I said, "This work may mean a lot of people calling. A lot of phone calls. A lot of articles and no doubt the day will come when the press and the media will come flooding in. It's all this you'll have to put up with." She didn't seem to mind.

So I came down and put a lot of stuff in stores and came down here. And when I went back to get the stuff much later, I was very ill, I had just got operated on. I was in a lot of pain. That was another thing she had to put up with because I couldn't hardly move. I had twice the pain I had before I went in for the operation. Then after a year she said to me, "Look, I'm not going to talk to you anymore until you go and see a doctor. You can't keep on like this." And in the end I went to the doctor and said, "Well my land lady said that if I don't come down and see you, she won't talk to me ever again." I said, "Well I can't have that." He took one quick look and said, "I can't do anything for you, you have to see a surgeon. I'll write a letter of urgency. You'll have to go in. They'll have to open you up to find out what's wrong." And a month later I was in and they operated. At least the added half of pain since I had the operation was gone when I came out the second time.

J.T.- What was the operation for?

J.S.- Well the first operation was to remove the gall bladder. And when I came out of the operation I had TWICE the pain. But they didn't take any notice. No matter how much I complained. And then in 3 days thrombosis set in. They were on the run then. They had me completely stripped. They had me lie on top of the bed while two fans just blasted cold air at me day and night. Then they had to find a drug that would break the blood up without doing too much damage. And that took a few days of tests and experiments to get the right drug and the right dose. And for about eight months I was on this treatment. But still they did nothing about that pain I kept telling them that I was in. And in the end I moved down here and of course I didn't bother to try to get any help until Susan said she wouldn't talk to me anymore unless I saw the doctor. "You can't go on like that. You can't hardly move. You can't get your socks on. You can't get your shoes on. You've got to see the doctor."

J.T.- So what did they finally find?

J.S.- Well when they opened me up they found that a hole had occurred and that fat had been pushing through it. And that's what was causing the pain. So in other words, they nicked something when they were cutting and didn't notice it. And after sealing me up, fat started pushing through and pressing on nerves causing quite some pain. It was agonizing. And of course I came out with double pneumonia so they were banging me to get the stuff out of my chest. And I was in all that pain. And they kept saying, "You've got to cough! You've got to cough the stuff out." And how could you. You couldn't. You were in so much pain. They said, "You'll die if you don't!" I said, "I can't. How can I cough when I'm in such pain?"

So when I went for the second operation I told them what happened. I came out with double pneumonia and thrombosis. So they gave me treatment before I went in for the operation to stop the thrombosis and hopefully any pneumonia attack. And I came out and didn't have this trouble because they were aware of what could happen.

J.T.- So they finally got you straightened around.

J.S.- Well, they have, except they haven't stopped the original pain. The original pain from the first operation is still there on the same side as the operation. But still, the way I look at it, I think personally I've done very well. The house shows for a person with no natural balance who depends on shear force and energy on his part to do it. At my age I'm still doing very well and I think I can match most people. Anyone who is really arguing whether at my age I am capable of doing something like STARSHIP EZIKIEL would, if they come here, realize that I'm quite capable of doing it, because they wouldn't want to try to do what I've done here. A number of people that have come here say, "God I don't know where you got the patience."

J.T.- It's amazing. I don't know how you carry on sometimes.

J.S.- Well, sometimes when I look back I'm amazed that I've survived.

*I asked John what happened to DEMO 1.*

J.S.- One day we set off and I decided that we'd try to find the place where I built the DEMO 1, as Luis had never seen the DEMO 1 in reality, we tried to uncover it so he could see it. Of course we had a bit of a job to find the place, but in the end we found it.

We went up to the house and we couldn't see the DEMO 1, so I knocked on the door. A lady came and I said, "I've come to see the flying saucer." So she said, "Ah!, It's gone. It was moved four months ago. You just missed it! We've had people from Australia who have come to see it! We've had lot's of people come to see it. "Oh", she said, "That was a great day when John Searl was building it here." As we were talking to her I was trying to place who she was because I never had her on my team working. How could she know all this? Nobody should have known this! So we kept talking and talking and she was going on to Luis about all the excitement and how the television people got up into a tree to take a photo from the top of the tree, looking down with John standing on top of the DEMO 1, so they could show the size of this thing. And then he fell out of the tree.

Then after about twenty minutes I said to her, "Are you Alf's wife?" You see Alf had owned that land that we were building on. "Oh yes!", she said. I said, "I was wondering! I was wondering how you knew all this. Because nobody should know anything about this." She said, "No, I used to watch thru the window and Alf would keep me up to date with everything. And when you lot were gone, everybody knew, everybody came to have a look. We had all the area in. Everybody knew!" I said, "But it was supposed to be secret!" She said, "Oh yes, he used to fly them just over there on the green." Pointing to where we used to test them. Then she said, "We had a shock. We saw him on television, flying an airplane. We couldn't believe it!"

After all of that she asked me, "How is John Searl these days?" And I said, "I am John Searl." And then the penny clicked.

J.T.- Do you have any of your equipment left?

J.S.- No everything's gone. I've found some of the stuff in Birmingham, in a shop. And I went in the shop and said that's my name on those things. I recognized those things as I walked by. I say, "You just lift them up. Open it, you'll see my name." I told him what it was. He says, "I'm sorry mate, I paid for this stuff."

J.T.- What was it?

J.S.- It was some of the equipment that I used for the flying side. There was a radar unit, there was the oscillator that controlled the speed, which I could control the speed of the motor and some of the equipment that can be seen in the film that we have that the television sent out, that was used for the timing of the takeoff. We found these in different shops in the Midlands! I was shocked! In fact the girl I was with said to me, "That's funny. Come back to the shop. I've just seen something that you've been telling me about." We headed back to the shop. She said, "There. That's what you've been telling me about!" And I looked and said, "Yes! That's my equipment!". We went in and I asked the man to open it up and there was my name. The woman was right. She recognized it from the things I've been telling her.

## INFORMATION TO PUBLIC

J.T.- The only way you're ever going to get it going is to let it out to the public so it can't be suppressed by the governments. They're just too greedy and want to keep everything based on oil, and your unit would eliminate that need.

J.S.-YES! It would kill off pollution overnight! And clean the air as it runs, and this is something no other motor does. It does not pollute, so it is a device that should be pushed with everything possible. But everyone who comes to me wants to just grab it all to themselves.

J.T.- Are you giving your information then out to the public?

J.S.- Yes. I've been lecturing in Europe quit heavily, discussing the work and I've had heavy publicity in the German magazine "Space and Time". It's very good stuff. Very long, lots of pages issue after issue. I've also had articles printed on my work in the magazine EXPLORE recently.

J.T.- On your papers you're putting out are you showing a detailed way you're making your motor?

J.S.- All the full tables have been printed. So one now only looks at the table. One works out the volume of the area that's going to be filled with the powders. And scanning down the chart of figures until you find the figure you want, look across and it tells you the choice of which square blocks to use, 3-4-5. That means how many powders you can mix together to get the results. Then you run up the square we show. You run up to that level that's close and those are the figures, the amount you have to mix in layers to cause a condition that will allow you to print it. And the frequency is given in the table for printing.

J.T.- Are there any video tapes of your lectures available?

J.S.- There's a video available of my lecture in Munich on the 18'th of last year. I've given out some of the powerful stuff in that and you can see some of the work that was discussed at that meeting.

J.T.- Things seem to be going pretty good.

J.S.- Well things are going good now. I am listed in the International Who's Who now and I'm not living in a Council House as I was in the past when I was interviewed by the press. They always mentioned that and said that anyone living in a Council House wasn't capable of doing anything.

J.T.- What is a council house?

J.S.- Well a council house is a house built by the government and rented cheap for the poor. We're in a private house now. That makes a difference. I've got the drawing put up in the porch now that used to be the outside, which is now inside. We built that in. Now the drawings of the magnets and of the disc are up, and I've just taken the big color drawing of the disc to the framers to get it re-framed. All I'm waiting for now is for the certificate from Who's Who to put up on the wall so that people will see that at least you're recognized. And if I do get into the science and engineering issue, that will also add more weight.

The work on the S.E.G. home power unit is progressing and an effort to get the price down to a realistic amount is now the main concern. Various elements are being tried out in the experimentation phase and full production will start as soon as these problems are ironed out. We are still looking for backers for the production of the flying craft. There has been interest shown by various nations in this respect.

To understand how the S.E.G. functions and what is needed to build it you must read the books on THE LAW OF THE SQUARES. That is the only place you can get an accurate account of how the SEG functions. All the charts and explanations are there. You must only open your mind to this new technology to be able to understand and appreciate it.

In reading this book you will see that John Searl has suffered many hardships, both physical and mental, in his quest to give this technology to mankind. As I look at his life, it amazes me that he has had the courage and fortitude to go on with this quest.

Many readers know of others, who have had ideas and technologies, who have been "slapped down" by the established money controllers of the day. These people have stopped progress and new ideas throughout history in the name of science and religion and government security. Many of the people that we revere today as great scholars and scientists were at one time persecuted as cranks or heretics to the teachings of the church. How much knowledge has been lost to us through the ignorance and greed of people who are only interested in themselves and their own interests? Most people who are "slapped down" by the establishment never recover. They give up on humanity or are persecuted to the point that they can no longer give their ideas or views to anyone. No one will listen.

This book is about one man who has not given up on humanity and refuses to be stopped by the greedy, corrupt people who would try to prevent his work from becoming a reality. If we as an intelligent people want technology such as this, we must fight for it. It will not be presented on a silver platter to you like a new toy on the market. There will be resistance to this new technology, but if you want it, it is here for the asking.

Prof. Searl is 61 years old as of 1993. This will be the last time he will be able to offer this to the world. Do you want it? That is the question. Only you can supply the answer.

CHAPTER 7  
*The Pole Shift*

## POLE SHIFT

J.T.- You were talking about the possibility of a pole shift.

J.S.- Yes, now nine years to twelve years away.

J.T.- You say that that is in 2003?

J.S.- From the third of May 2000 to the fifth of May 2003. This is the period where we can expect drastic changes due to the pole shift.

J.T.- Now where did you get this?

J.S.- Well we've been looking at all satellite data for why the earth has had pole shifts before.

J.T.- How often does this occur?

J.S.- We've had them seven times before. They will happen again and again and again because it's a natural phenomenon. What happens is when a top spins, things do sometimes build up on a spot. Now as it builds up underneath, and you can do this to any top you like - any big top. If you spin it before you put some nice heavy little lump on some spot underneath, and watch how long it wobbles before it falls, you'll see that it takes a long time. But now build a little weight, like lead, put a lump of lead underneath at one spot. And now see that it only takes a few wobbles for it to fall and it will fall in the direction of that bump.

Now the earth has such a bump building by thousands of gallons at one spot called "Little America" in Antarctica. And that bump will cause the earth to tumble quicker than normal. Normally every eleven years Jupiter passes in back of the Sun. The Sun spews out a mass of activity and it spins the earth up. Now the problem is, if the earth is heating up and things are getting unbalanced, the earth is slowing down quicker than it should be. Jupiter's impact will be pretty strong, but the one thing that we have never had modern science around to check is what happens when two giants come together behind the Sun. Which will take place around the third of May in the year 2000. If Jupiter could do all this damage to us, will two do twice as much damage? In fact where do these two forces have to be to apply the maximum effort on the earth? With such an impact hitting the earth when it's at it's peak wobble, it will knock it completely over. So it just keeps turning over and over and over in space and everything will get destroyed. Or will it just knock it over to a new pole shift position?

J.T.- Well even a small shift would be catastrophic!

J.S.- Oh yes! You're going to whip up winds of over 500 miles per hour or 1000 miles per hour for about four years.

## Chapter 7

J.T.- Boy! I hope we can get these things built before then.

J.S.- Well we want to. Because we're looking at lots of areas except the equator belt, suffering immense winds. There will be lots of places with water that will suddenly have no water. Volcanos being disturbed. Earthquakes.

J.T.- Yes, there are a lot more of them going on now.

J.S.- Yes, we're looking at something which no modern records have been able to ever see before. Man's records of the past were so badly destroyed that we cannot get enough facts but we didn't know what was causing it. A lot of theories came up but now I think the one I put forward the last few years is probably the true one.

J.T.- That must be in your new book.

J.S.- Yes. I've looked at all sorts of things. But the dreams says that I will live to see life all around me gone, destroyed. And that I will see fires greater than anything before by ordinary man of the present time has seen. But I have no need to worry. I shall be lifted from it. I think what it means is that the flying machine, manned one, will be built in time.

J.T.- Do you think that that's the only escape?

J.S.- That would be my escape route. Now everything about the dream has come out true. The mathematics in the dream have come out true telling you how to do the squares. It must be that the dream is true. I am to see this great destruction of this planet and witness it.

J.T.- We still don't know the exact date do we?

J.S.- Well I know that in two and a half years time the beginning of the run that will lead to the start of the end. And then in the year 2000, that is where we expect the peak.

J.T.- So you think it's 2000 rather than 2003?

J.S.- Yes, the change will be weather due to pole shift.

J.T.- Do you think the pole shift will be gradual?

J.S.- No it will go suddenly when it goes. We have that record of the pharaoh who used to watch the sun set in the East. And he wrote, "I walked my usual evening walk to see the sun set in the east. And after the sun set I turned to go back and I was surprised to see that the sun began to rise again in the east." So the earth at his point had swung 180 degrees in a split of a second. And because he was at the center point he didn't feel



the effects. But one thing we are certain of. That the Antarctic froze instantly, freezing all the creatures. Mammals eating tropical plants and such. So we know at that time, up to that point, some people probably lived there. People certainly traveled there and drew up the area for maps. And we know from animals that have turned up by the thawing that's been going on that they were taken by surprise. They were instantly frozen. Because they had tropical plants in their mouth. There were tons of tropical plants around. So it was quite a hot place. Now suddenly it was covered in ice and we know that the ice is mounting very fast because back in 1928 those great high radio towers, 110 foot, were put up for broadcasting from the people who went there to study. There's only one left that shows a couple of feet or so above the snow. All the others are covered under snow. It's done it in that time. Millions and millions of gallons of fresh water, all frozen there. And although the ice is melting at an alarming rate at the moment, what people forget is that in Little America, where these towers are, that's more the center of the icing period.

So it is the edging which is folding back towards it. And at this rate the sea must have increased its height. And we know this is so because some islands have disappeared and other islands are threatened. So we know that the ice cap is certainly shrinking. We know on the north pole side the ice is moving towards New York. It's slowly increasing so I think what we're looking at is the method by which the earth replenishes an area, then freezes it to rest it so it recovers. And it moves about like this. And this is how the earth keeps on replenishing its energy.

J.T.- Like a cycle.

J.S.- Like a cycling event. The other thing too. What we often forget. We always talk about our orbit around the sun as elliptical. It is elliptical but it moves out of shape every so often and forms a circle. It goes around...and it takes about ten thousand years to switch from elliptical to round and back to elliptical again.

So when you go round it means your periods of heat and cool changes completely. These points or levels will be at a precise point and constant. And when you slip into an elliptical they change dramatically. So you get this swinging. But the trouble is we shoot away with statements scientifically certified and we never stop really, to decide whether this statement is absolutely true or have we accepted what we think is true and made it true. And that is often the problem. That is what is happening.

Then some years later things don't match the picture. But even in the ancient times they always talked about this great destruction. But I think the most interesting thing is when you start looking at things like past ice ages. Mammals suddenly disappearing off the face of the earth. Then you start looking at why these things happen. No real scientific explanation can be given. Then you have to ask yourself, "If there's no scientific evidence that can support the reason for this we must look outside of the earth for some explanation.

J.T.- Well the alignment is coming in the year 2000, I can see that.

J.S.- Yes, so we are looking for an alignment whose forces may cause our sun to put out more energy than normal. And this energy would be the destructive force. This is what I feel is more realistic.

It sounds more realistic based on what happens every time Jupiter passes the back of the sun. So if you get two massive electrical magnetic forces piling on the back of the sun, it is likely to make the sun spew out not just double the amount of energy, but probably treble or quadruple the energy at the earth. And this may be enough to set off volcanos and earthquakes and cause the earth's atmosphere to get so thick and packed with dust that the temperature just drops suddenly. Or it can knock the pole into the reverse position, and if it does you've got an instant ice age in the new area.

J.T.- Do you think it will go 90 degrees instead of 180 degrees?

J.S.- Well it's always difficult. All I know is at this time the earth is really rolling slowly and it's really wobbling bad. And I know from experiments with tops, an immense amount of research, is that if it troubles too much and you suddenly hit with a force it falls completely. It can only pick up speed and race off again if you catch it before it reaches a given wobble point. And I was just wondering, the wobble may be alright for just Jupiter passing in back of the sun but it may be too much for two giants to pass in back of the sun. And it might cause the earth to tumble.

J.T.- Yes that would explain what happened to Antarctica. What can we do to protect ourselves during the shift?

J.S.- We're meeting a lot of new firms now in designing new products ready for this technology. The new house we'll design will withstand the highest wind you will ever get on this earth. It takes all the energy of nature and converts it to useful energy for you to use. It's germ proof, weather proof, sound proof, burglar proof and fire proof. There's nothing about this building which you can say looks ugly. It's design is very pleasing to look at and it could probably stand longer than the pyramids stood. And yet I don't expect it to cost any more than a regular house to build. But with an ordinary house, it is not expected to withstand winds of 200 to 300 miles per hour which are coming. They're not designed to withstand immense cold. They don't prevent pollution from coming in. Burglars can get in. Fire can destroy them, and repair work has to be done. Well this house, when built, will have no repair work that has to be done. Of course you will have to replace an electric lamp when it blows or element in a heater, but the structure itself does not deteriorate.

## METEORITE COMING

**J.T.-** You had mentioned that some meteorite is coming. Where did you hear that?

**J.S.-** Yes that is a big meteorite coming and that will hit the earth. But that is about 2025. That was measurements made by NASA. It was located by that big radio telescope that they are doing a scan of the sky with. Of course everybody thinks they are looking for UFO's.

But they said that if there are any UFO's around that they'll find them. But what they want to know is precisely what is out there. And they're scanning a massive area and they hit on this boulder that's racing towards us and will impact on the earth in the year of about 2025. They are trying to work out a system of rockets with nuclear war heads to try to break it up before it reaches the earth. They are working on some laser work to see if they can smash it with lasers to break it up so it won't damage the earth so much.

**J.T.-** Oh, I haven't heard anything like that here.

**J.S.-** Yes, it's quite a big scare on in NASA. They're really worried about it. They're scanning to see if there's any more.

**J.T.-** It must be really big!

**J.S.-** Yes it's a real "biggin". I forget what the size was, but they did give an estimate that if it hit London, it would wipe out most of Europe.

**J.T.-** Well if you had Starship Ezekiel you could go right out there and turn it.

**J.S.-** Yes, if you had Starship Ezekiel, you could go right out there and de-accelerate it using the field of the craft. Then you could push it out and away.

You may choose not to believe that there is going to be a pole shift in the near future, but Prof. Searl does, and he is trying to do something about it.

Whether or not the pole shift is coming, his designs for a new style house that will protect its inhabitants would be a boon for mankind. His design for the home generator would be the answer to our energy needs without pollution. His Levity Disc, or Inverse G vehicle, as it is now called, would open the doorway to safe and inexpensive space travel as well as opening up efficient fast transportation here on earth. Whatever Prof. Searl's motives are, he is offering a better future for all mankind. All we have to do is accept it.

In today's world there is an economy that runs things and this economy is based on profit. There is much greed and corruption involved. Who among you can say that we as a nation, or for that matter, a world, are living in the future that we wanted as a child? Governments have been influenced by the greed of big business. Big business runs the world and their prime objective is not the betterment of mankind, rather it is the objective of making more money which translates into power. Thus we are still plagued by wars and unrest. The "haves" fighting against the "have nots". No one wants wars, but they have been with us since recorded history with no end in sight.

Perhaps in the face of a common threat, such as a pole shift or another natural catastrophe the world would pull together and ignore our differences so that we, as people of the earth, could survive and prosper. We should not have to wait for this type of catastrophe or be driven by it. Children are told by their parents, "Get along with each other and stop the fighting. Do something constructive for a change!" We as a people have fallen into the same type of pattern as these children. We all want what the other has. We want to all be first. We want to have more than anybody else has.

Some of you will say, "We need competition to keep from boredom and complacency". I say we have a great task to fulfill in this world. One that will take all the energy and innovation of everyone in the world. This task is to rise above the greed of the world for the betterment of all not just the few. This would not mean giving up anything, only adding to the whole.

We know that industry has sometimes held back new products or processes so that they could sell more of what they have for sale now. Then when the market is saturated, they come out with the new item or process. This way they capitalize on the people rather than providing for them. This slows progress immensely. They seem to be building more things with built in obsolescence so they can sell more of the same item. This is most evident in automobiles. We are no longer in the industrial age but have slipped into an age of making the rich richer and powerful more powerful.

Science has made many strides towards the future with the space program and in medicine. Most of these strides have been made as a product of the strife for military supremacy both on earth and in space. It is time to move ahead with a new motive and goal for mankind. We must abandon the fears of new products and new ways of doing things. Progress in new fields will increase jobs, not decrease them. The manufacturers of buggy whips fought the new automobiles that would put them out of business, but there are far more people working on automobiles than ever made buggy whips or horse shoes or horse drawn wagons. The smart manufacturers changed with the times and benefited from the new products of the time.

In the research that I have done, I have come across many people who have had what the scientific community calls free energy devices. Some were capable of flight. All were capable of producing energy with no discernible input. These units all used unconventional means, using existing laws of physics, to achieve their results. Most of these devices were either destroyed or discredited by the big money that would lose immediate income. The only man who got any press coverage, as biased as it may have been, is John R.R. Searl. There was no denying that his remote controlled Levity Discs were real. There they were, in the air, for all to see. There were thousands of feet of film taken of his various crafts in the air during public demonstrations. And be-

cause he had so much press coverage and public interest in his work, he was a real and immediate threat to the utility companies and the airline companies, not to mention the oil industry. It is no surprise to me that he was stopped and an effort made to discredit him and his marvelous work.

The work being done today is done in secret because of this. What happened in the past must not be allowed to happen again. The world is in trouble and needs this technology badly. Public support and backing is needed now. Let us not stay in darkness to please and feed the greed of big business and corrupt officials who prosper at our expense. We can move into a new age if we choose it, but we must choose it. It can not be forced upon you. You must want it and pursue it yourself. We have been led by the nose too long.

What exactly would the production of the SEG and the Inverse G Vehicle do for us now? The home SEG generator would supply enough power for the entire home with no need for fuel of any kind. This would mean free electricity for any need or use you choose. This would include heating the home so there would be no need for burning of any fuel. The SEG generator can be made in any size required so it could be used for factories and high rises as well as for the individual home. There would be no need for conventional electric power that is presently being generated by the burning of fossil fuels, nuclear fission reactors and water power. To put the SEG to use immediately, a large unit could supply an entire city using the existing power lines.

The SEG could also be incorporated into an automobile to power an electric motor. This same principle could be incorporated into any form of transportation vehicle on land or sea. This would include trains, subways, buses, ships, boats and etc.. Anything that can be run with electricity can be run on the Searl Effect Generator.

Aircraft that is powered by an SEG called an INVERSE-G-VEHICLE would replace the jets of today. Flight times would be cut drastically using this new vehicle. There would be no sonic booms because of the way the unit operates. It does not cut through the air but directs it around the craft with a field of energy. There would be no need for long runways at the air ports as the Disc can land in an area slightly larger than its diameter. Once inside the craft you are no longer subject to the existing laws of inertia on the earth as you are now within your own sphere of relativity, that is to say you are within your own separate planet. As such you will be able to travel at extreme acceleration rates with no side effects. An artificial gravity is formed within the craft of about one half that of earth so comfort is insured. This holds true for travel outside the earth's atmosphere as well. This is how you will be able to travel to the moon or another planet at extreme speeds with no discomfort.

The need for cranes for lifting objects will no longer be needed. Once an object is within the field of the craft it loses its' weight and can be moved easily. This method could be employed to lift extremely heavy items or lift things from hard to get at places much the same as our helicopters do today.

There would be many uses for this device as you can see but the most important effect it would have on the earth is that it is pollution free. Because of the nature of the propulsion system it would actually help "heal" the ozone layer that has been damaged. We would be working with nature instead of against nature. It is time we the people of earth started to heal this world and stop destroying it.

## PROF. JOHN R.R. SEARL'S BOOKS

Prof. Searl has written a series of books entitled "THE LAW OF THE SQUARES". To date (1999) there are 14 books completed. These books are being offered in manuscript form. They have not been edited or changed in any way. Since Prof. Searl is dealing with new concepts and new ways of applying existing physics in his work, any editing may change the content or intention of the work.

These books transverse many subjects and contain the personal views and appraisals of Prof. Searl as well as giving the reader an insight as to how his SEG (Searl Effect Generator) is constructed and operates.

As readers and seekers of the truth we are very fortunate that Prof. Searl has decided to carry on with his work. He has had to endure many hardships and setbacks in his life. Many men would have given up in the face of such opposition and treachery. I feel privileged and honored that I have had the opportunity to get to know this man who is an independent free thinker. I regard the knowledge that I have received from him and his books as a precious gift. To me, he has the same kind of inspirational creative genius as Tesla and Einstein. In Prof. Searl's words, "I have given you the answers. It is up to you to come up with the right questions."

Most of us are aware of the hole in the Ozone layer above the earth. We also know of the mass destruction of the Rain Forests. We read about the nuclear waste from our power plants and its very long half life. We see our factories belching smoke and our rivers and lakes being polluted. We know about acid rain and dead lakes.

These things seem far away from our everyday life. Most things still seem normal to us in our day to day lives. But one day we might wake up to the fact that we are too late to repair the damage done to our environment.

The Earth will survive. The Human Race may not.

Yours in the work,

JOHN A. THOMAS, JR.  
373 ROCK BEACH RD.  
ROCHESTER, NEW YORK  
14617-1316

PHONE: 716-467-2694  
FAX: 716-338-2663

# Sandberg Report

## The Searl-Effect Generator

### Design and Manufacturing Procedure

The objective of this report is to reconstruct the experimental work carried out between 1946 and 1956 by John R. R. Searl that concerns the geometry, materials used, and the manufacturing process of the Searl-Effect Generator (SEG).

The information given here is based on personal communication between the author and Searl and should be considered preliminary as further research and development may give reason to alter and/or update the content.

### The Gyro-Cell

The SEG consists of a basic drive unit called the Gyro-Cell (GC) and, depending on the application, is either fitted with coils for generation of electricity or with a shaft for transfer of mechanical power. The GC can also be used as a high voltage source. Another and important quality of the GC is its ability to levitate.

The GC can be considered as an electric motor entirely consisting of permanent magnets in the shape of cylindrical bars and annular rings.

Fig. 1 shows the basic GC in its simplest form, consisting of one stationary annular ring-shaped magnet, called the plate, and a number of moving cylinder-shaped rods called runners.

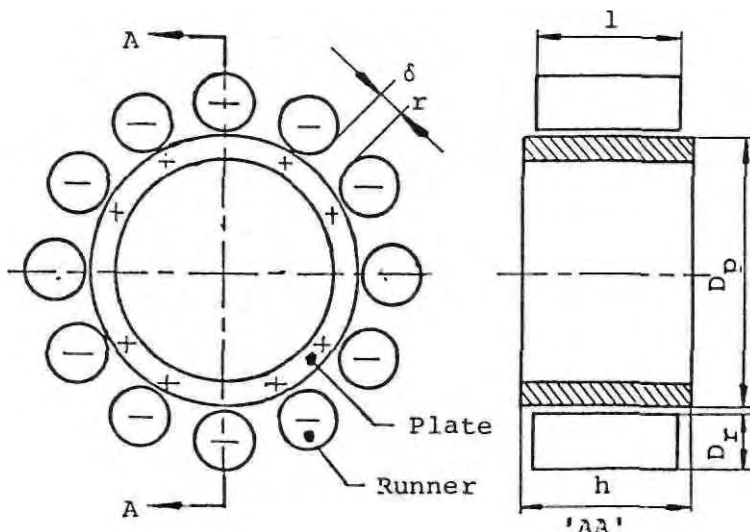
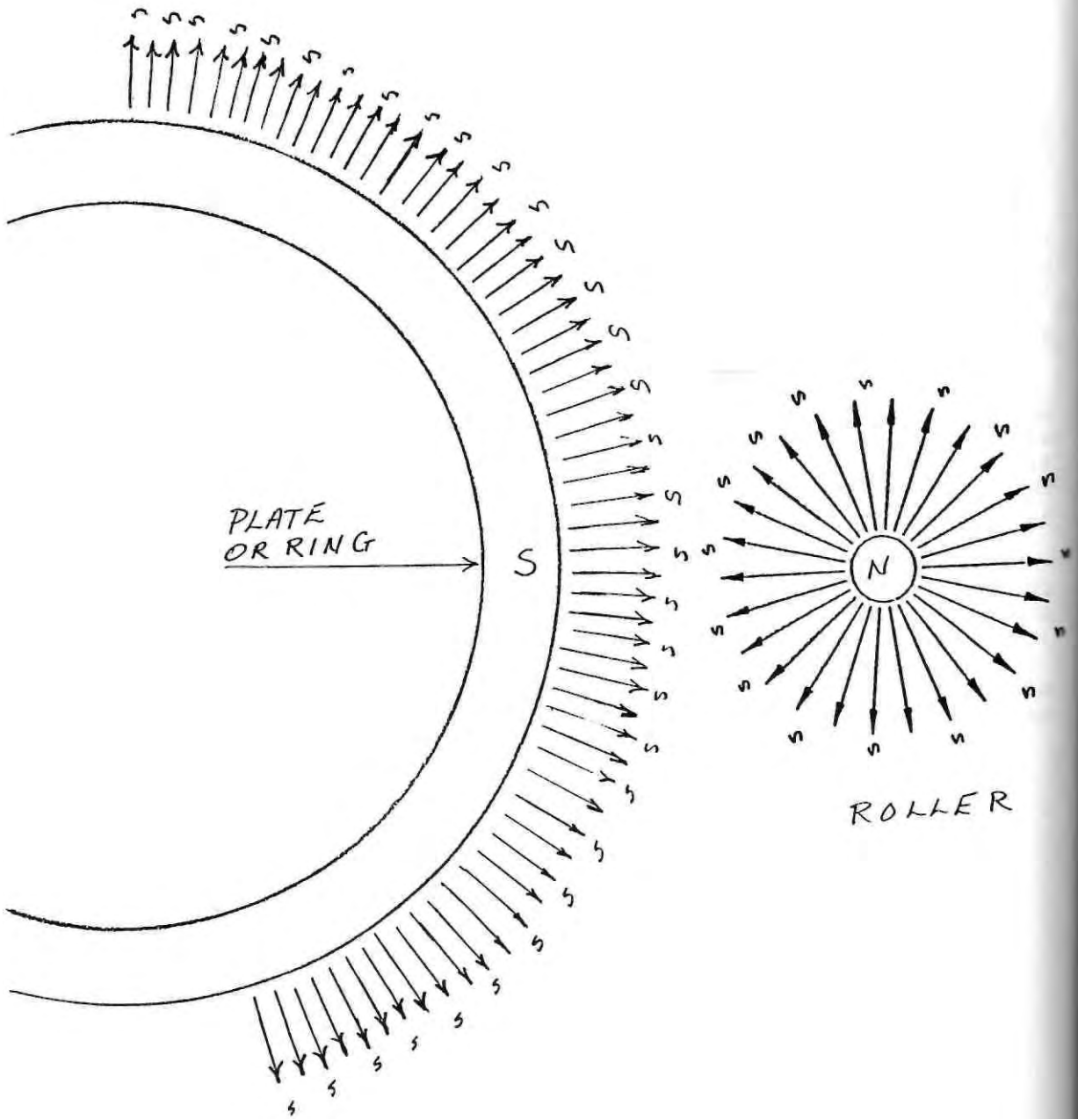
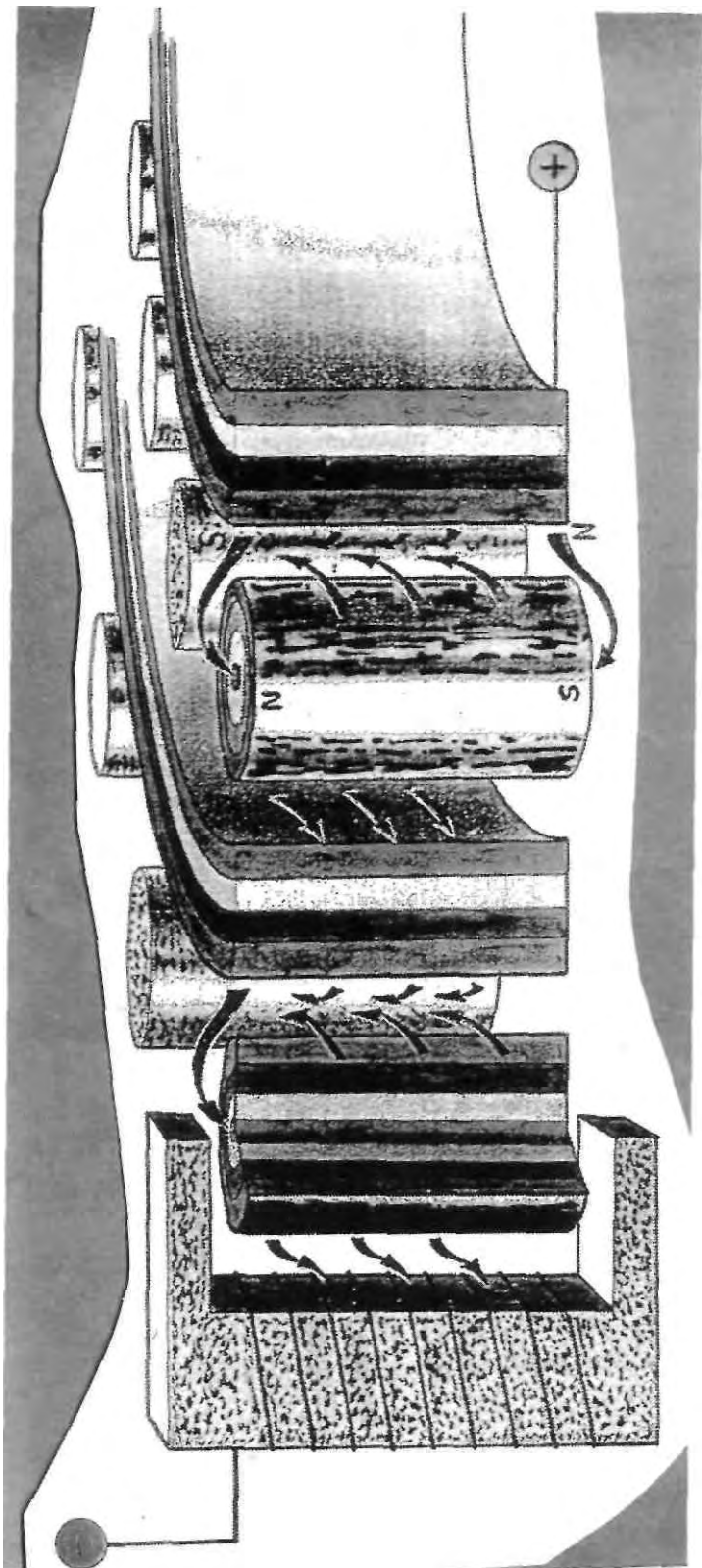
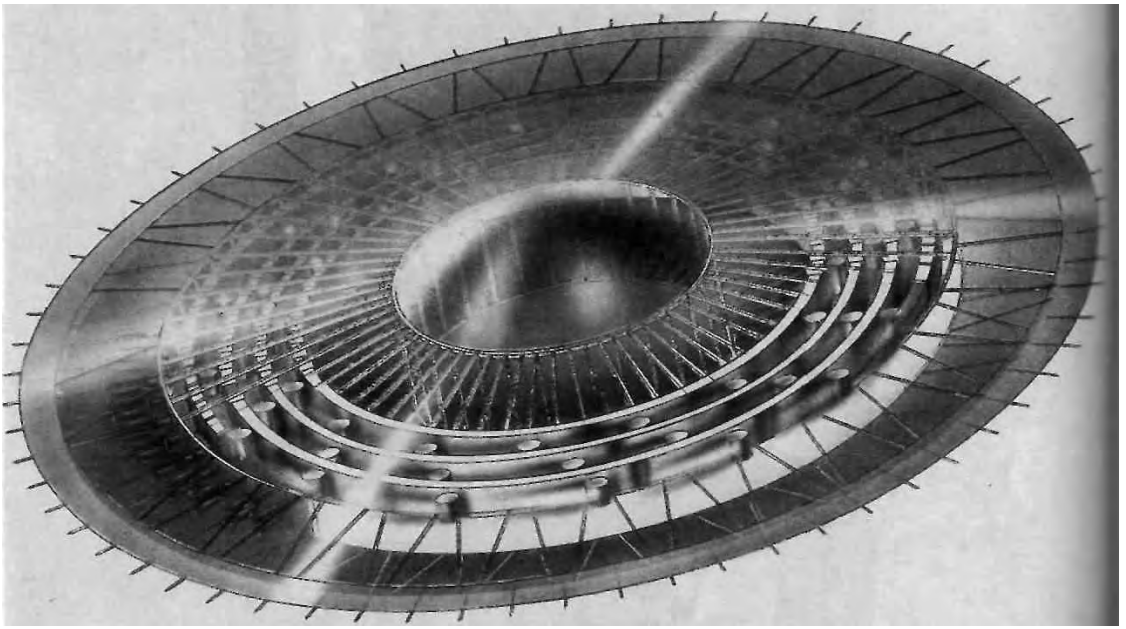


Figure One









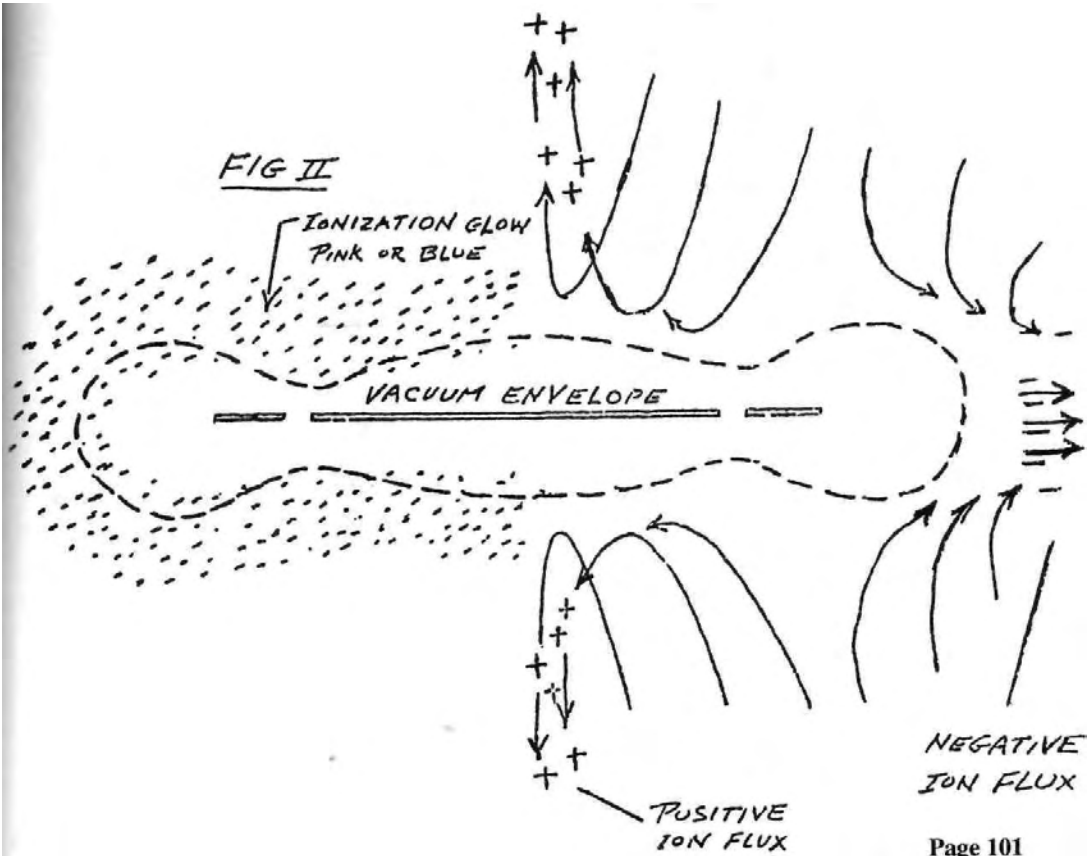
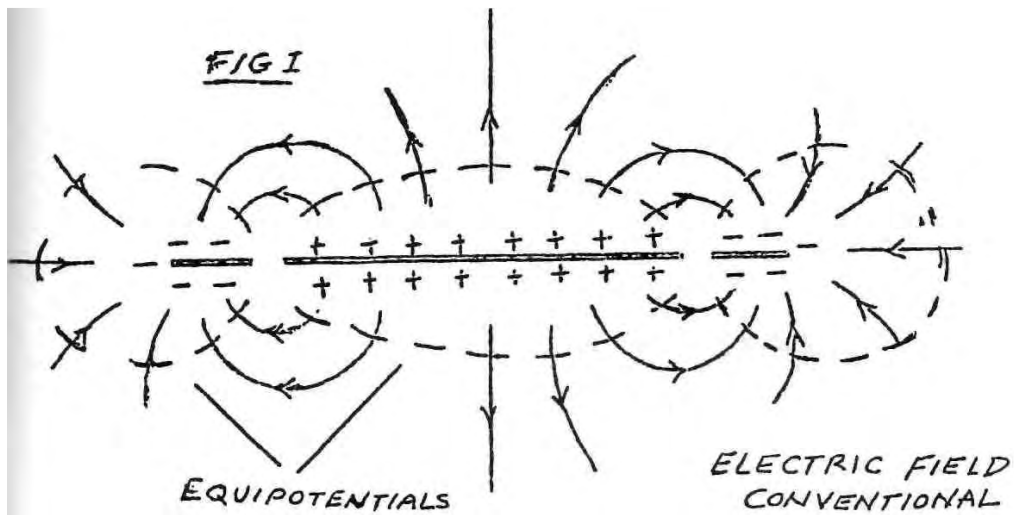
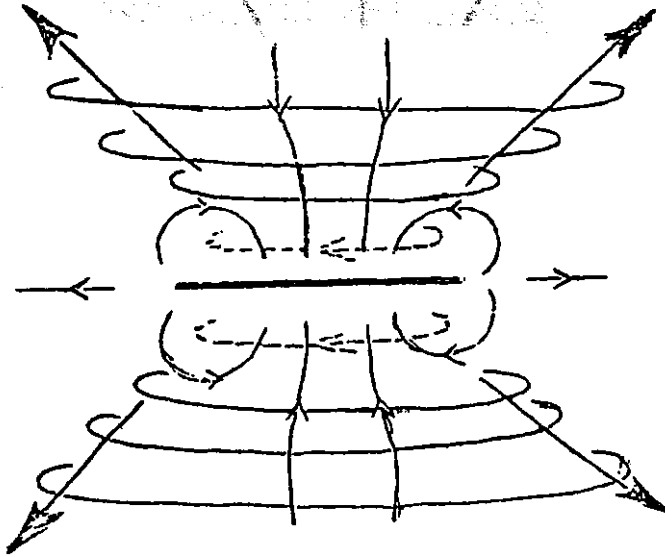
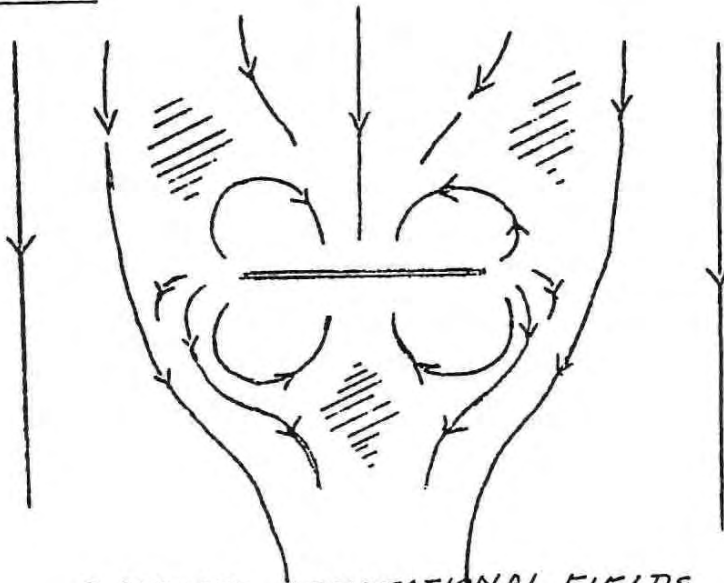


FIG III



- ELECTRONIC FLUX
- CONVENTIONAL MAGNETIC FIELD
- DYNAMAGNETIC FIELD

FIG IV



COMBINED GRAVITATIONAL FIELDS  
EARTH'S GRAVITY FLUX + ETHER FLUX FROM  
GENERATOR

DESCRIPTION OF PHOTOS BY PROF. JOHN R.R.SEARL  
JANUARY 17,1991  
RECEIVED BY JOHN A.THOMAS JR.

PHOTO 1:(TOP LEFT) STARPORT EARTH ONE, wood area to be cleared of trees etc. for the building of DEMO 1. Around 1968 (BERKSHIRE) (1971)

PHOTO 2:(TOP RIGHT) Trees removed,land cleared for building DEMO 1

PHOTO 3:(BOTTOM LEFT) Commenced making the struts for DEMO 1. Chap on the left wearing white cardigan is Brian Collins of Oxford. Chap on left in dark is Alfred Fleetwood who owned the land called STARPORT EARTH ONE. The object held up by them is one of the 64 struts of DEMO 1. The plastic cover acts as a shed to house 5 RADAR UNITS, each with 12 viewing screens.

PHOTO 4:(BOTTOM RIGHT) The same two chaps only the number of struts have increased. I myself made all 64 struts without help at 17 Stephens Close-Mortimer. They helped to move them to this site on Sundays.

PHOTO 5: The fellow facing us is fixing a strut at the cabin end. The chap, back towards us, is Tony Justice in white shirt sitting on top of struts working. The chap facing us is from the London University. I have forgotten his name.

PHOTO 6: DEMO 1. All struts are now in. Cabin not yet constructed. At the back of DEMO 1 is the first of eight landing legs for DEMO 1. The people from left to right front are the chap from London University, Charles Haskell, Sue Justice, Tony Justice, Brian Collins. Behind them, from left to right are myself and Gorden Goodfellow.

PHOTO 7: Tony Justice standing in the cabin of DEMO 1 with a glass of champagne to celebrate the completion of all the struts of DEMO 1.

PHOTO 8: Tony Justice building a part of DEMO 1. Center cabin telescopes front and rear viewing. This center controls the flight angle. Containing sensors all it's data is transmitted back to the equipment behind him. So we see on the ground what we would see if we were in board the craft in flight.

PHOTO 9: DEMO 1 shaping up. Tony Justice and Charles working underneath DEMO 1. (Note the posts (upright) are marker posts. All they do is to confirm that that the structure has not moved while we have been away all week, as we only worked Sundays, because it was on a hill, open to the weather which included 4 gales, many heavy storms, high winds and high sun light and the weight is increasing fast with each Sunday's work. I had to be certain it was safe for people to work under or on top of it. It never moved once from it's set position. (This shows how strong it was).

PHOTO 10: That's me in the foreground. I'm at a loss as to what I'm doing or what I have in my hand, but Tony and Charles are still working under DEMO 1. But now we see Sue Justice working on top of DEMO 1. She is fixing a part of the cabin. She is kneeling in the cabin. Tony is pushing a part up to her, to check for level.

PHOTO 11: At DEMO 1. I'm on the extreme left, with the jacket on. I'm telling Jim Goodes what to do. At the plastic shed containing 5-12 channel radar units for the flight operation of DEMO 1 is Tony and Sue Justice, selecting parts to fit in DEMO 1. (Inside the radar plastic shed are settees and chairs for the workers to have their meal) In front of the shed is a bench to cut materials for DEMO 1.

PHOTO 12: Charles Haskell taking a part he's just made to DEMO 1. It looks like a part of a flight cell. The radio by the way belongs to one of the workers and has nothing to do with DEMO 1.

PHOTO 13: Struts of DEMO 1 mounted. Tony Justice checking last one fixed (1972)

PHOTO 14: Commencing building DEMO 1.(Struts are being mounted)

NOTE: We are building a hill. -The right side is higher up than the left to keep the structure level. I think it's Tony Justice below the craft, I'm checking a strut mounting before fixing.  
(1972)

PHOTO 15: Outside the front door of 17 Stephens Close-Mortimer. From left to right Tony Justice, Sue Justice, Glen Huskell, Charles Huskell. The letter plate on wall is N.S.R.C.(NATIONAL SPACE RESEARCH CONSORTIUM).

PHOTO 16: Part of DEMO 1 struts now in, still more to put in on other side. Tony Justice on top of DEMO 1 fixing some internal part which Charles Huskell is giving him. Charles is standing on the ground. The SEG housing is complete on this section and is the wide white looking circle band near the rim, which is close to Charles.

PHOTO 17: DEMO 1 completed, except for the flight cells. From left to right are myself, Sue Justice, Rev.George Nicholson, Charles Haskell, Glen Haskell, Tony Justice and Arthur Cain. We are all standing above the cabin of DEMO 1. (It is skinned with plastic clear so one can see the structure parts.)

PHOTO 18: Color. This was taken from a tree - shows me standing on top of the cabin of DEMO 1. Flight cells not yet made. But craft has it's shells on.

PHOTO 19: The rim of DEMO 1. just being constructed. The space between the SEG and the rim is for the flight cells (64 off them). Persons from left to right: Gorden Goodfellow speaking to Tony Justice about what part the rim played. Charles Haskell also explaining to him. (Gorden had only joined us a short time so missed all the lectures on DEMO 1 planned construction).

PHOTO 20: The cabin of DEMO 1. It's equipment, airlock door. Center is the end of the telescope.

PHOTO 21: Start of wiring of DEMO 1. (This is the outside of the SEG inner wall). A small SEG is missed in the photo - producing 480 Volts for the DEMO 1 transmitter. From left to right- 3 X 20 way connector block, 3 block vertical of 4 way fuses. Then 7 of over 1000 20 X way connector blocks.

PHOTO 22: Tony Justice working on one of the 8 landing legs sections of DEMO 1.

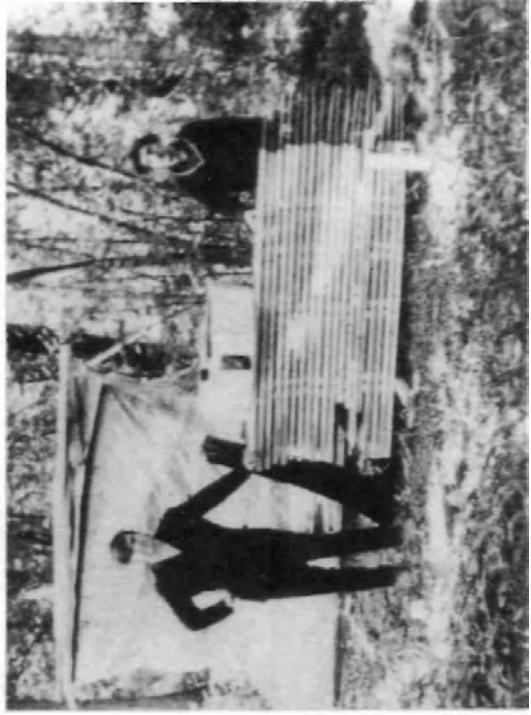
PHOTO 23: A one eighth section model of SWALLOW FM598 MK.II. The actual craft was 38 feet in diameter and was flown outside Warminster, Wilts. As you see the 64 flight cells were slightly different to DEMO 1. This was built in 1956. The cabin was for 3 men only.

PHOTO 24: A NON RETURNABLE MODEL for demonstration displays only. Straight up and away - very fast - between 1950-1964. (About 40 of them).

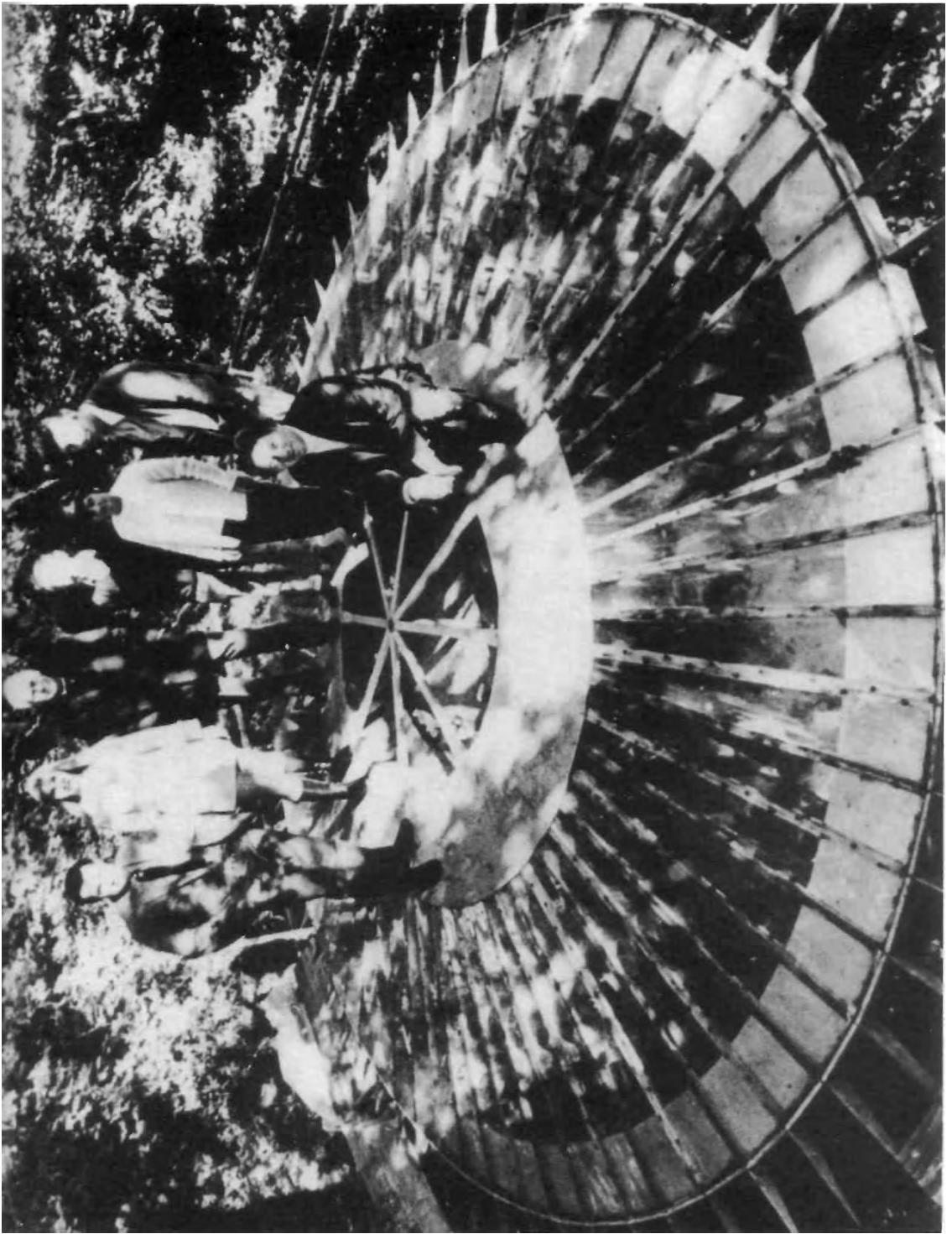
PHOTO 25,26 & 27: These are press photos taken by the Hants & Berks Gazette. (1973-1975) P11 on the ground, P11 hovering, I'm pointing up at the P11 to explain to the reporter how it flies. These were the 3 prints printed in their article but they took reels and reels of photos. These are only 3 of them.

PHOTO 28: P11 in full flight heading upwards to 15 miles. Rain is falling fast as clouds break up. The tall electric pylon is blurred by the effects, almost out of focus. This last one of the press must have been world famous as it has appeared in many papers and books.



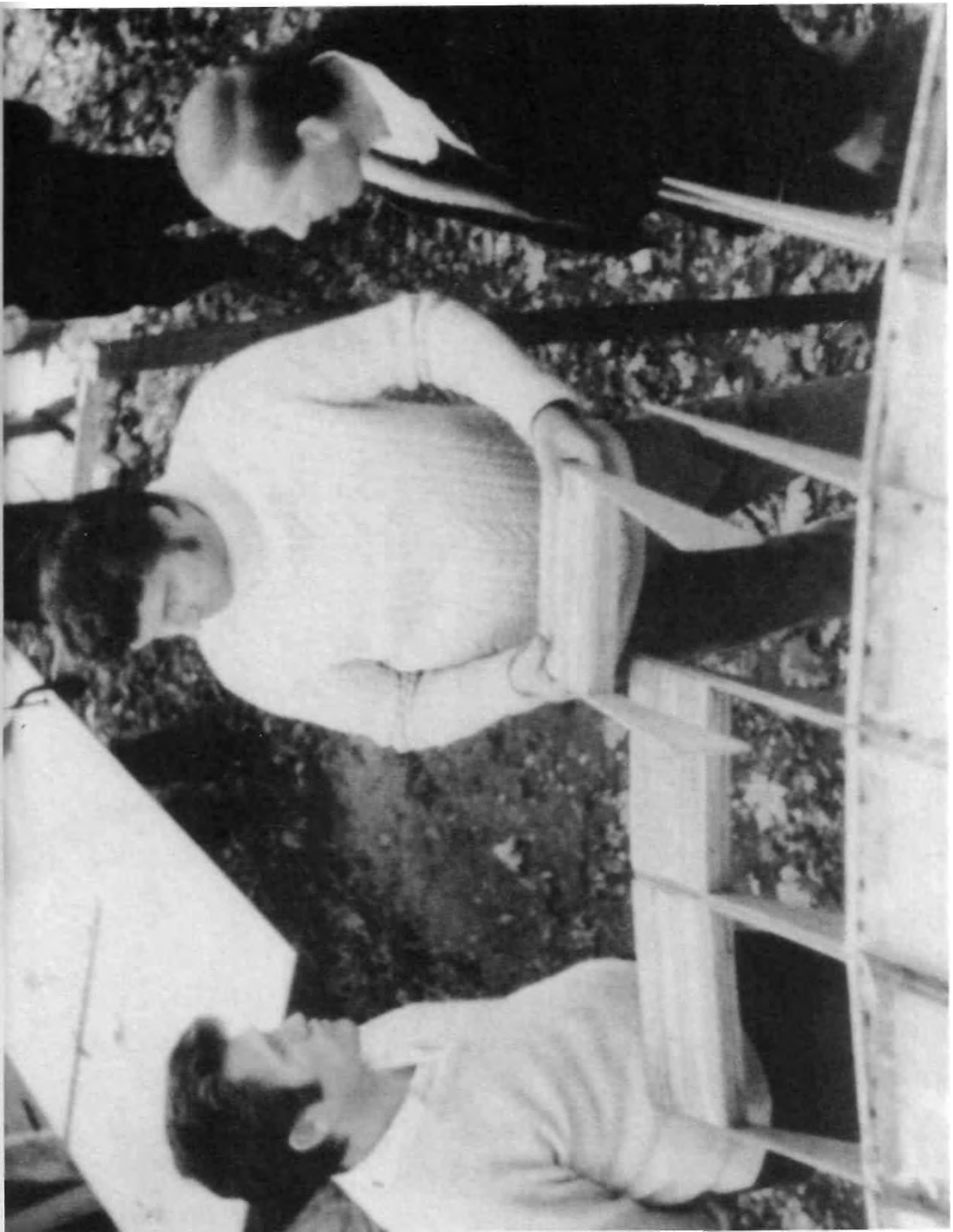




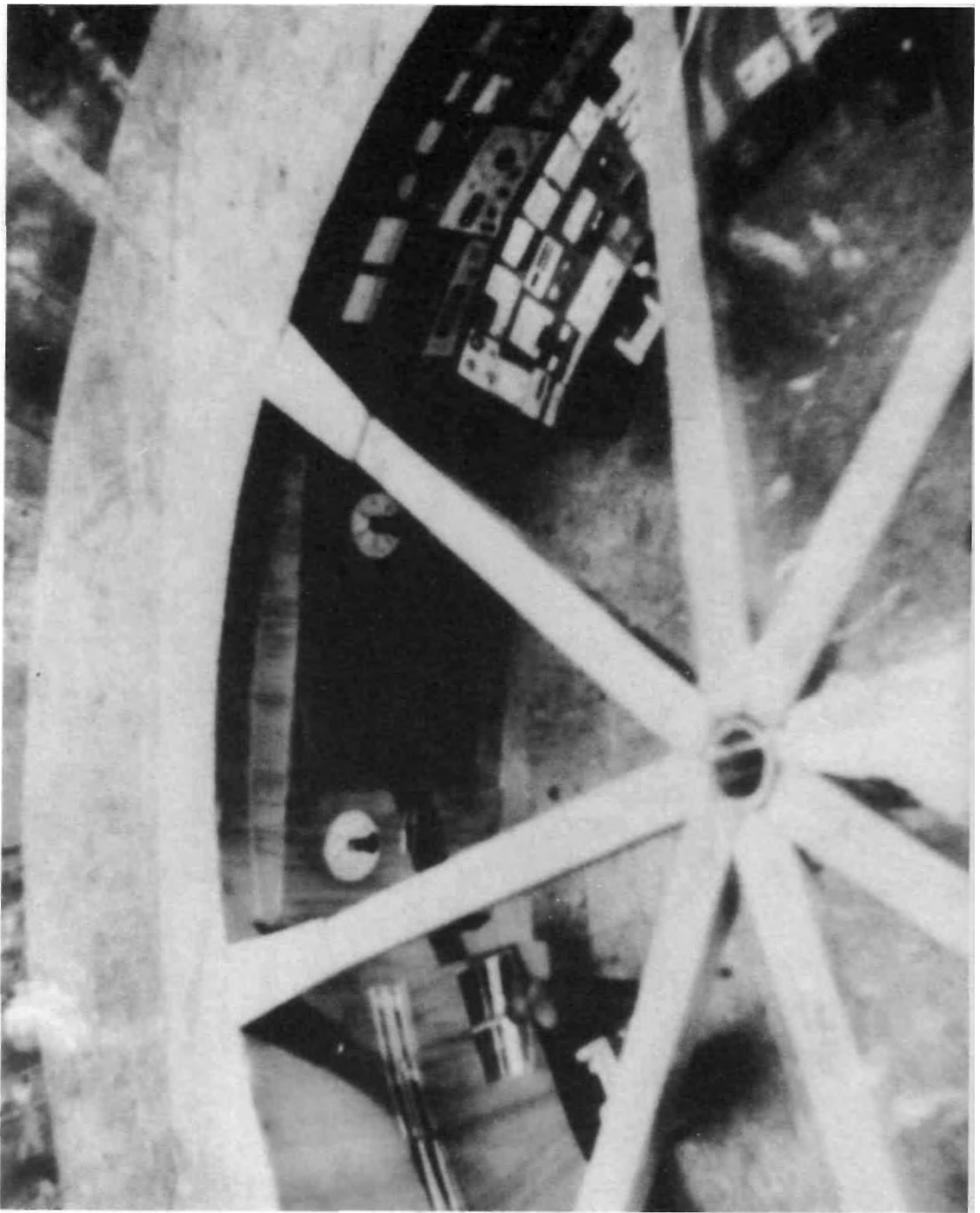


*Photo 17*

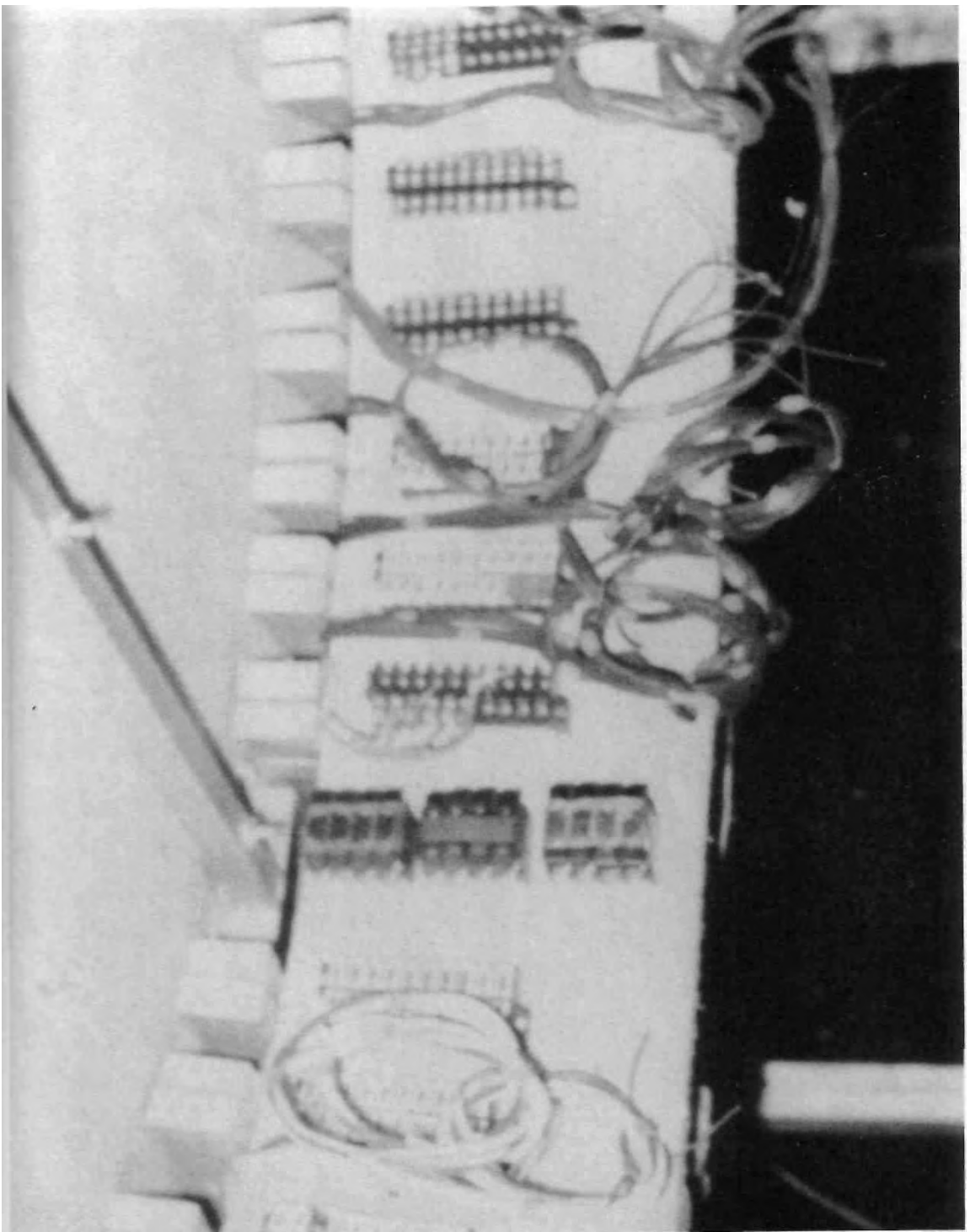




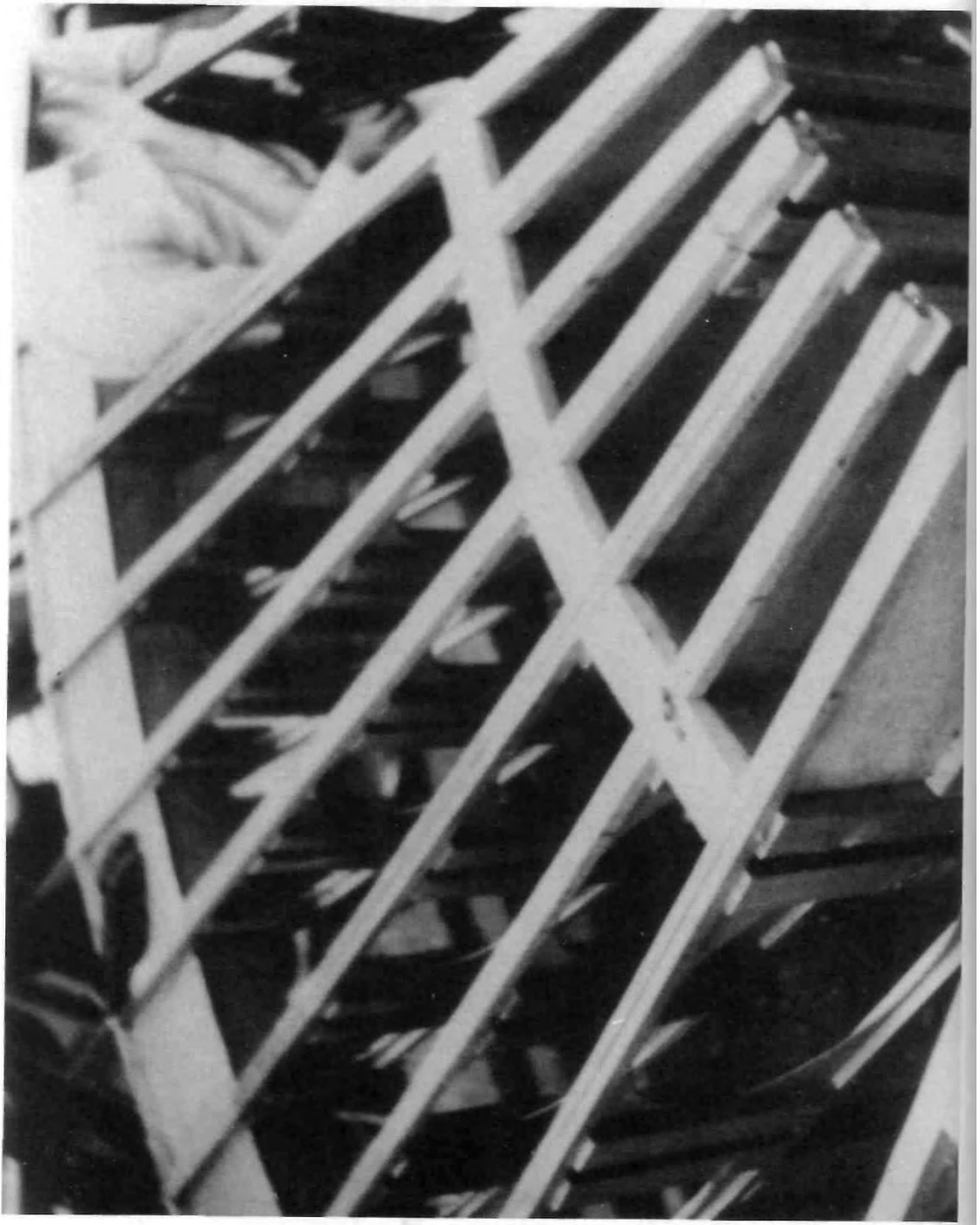
*Photo 19*



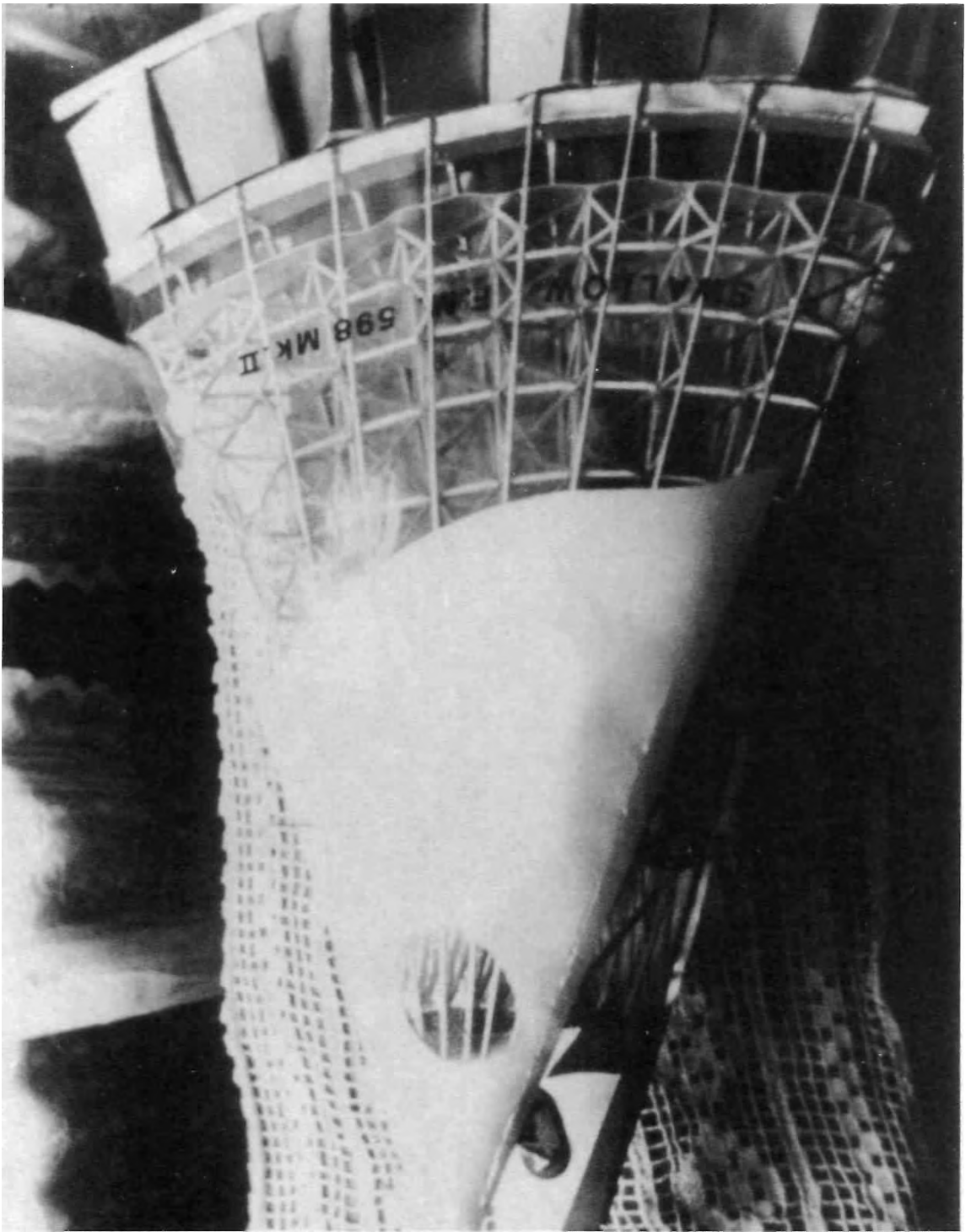




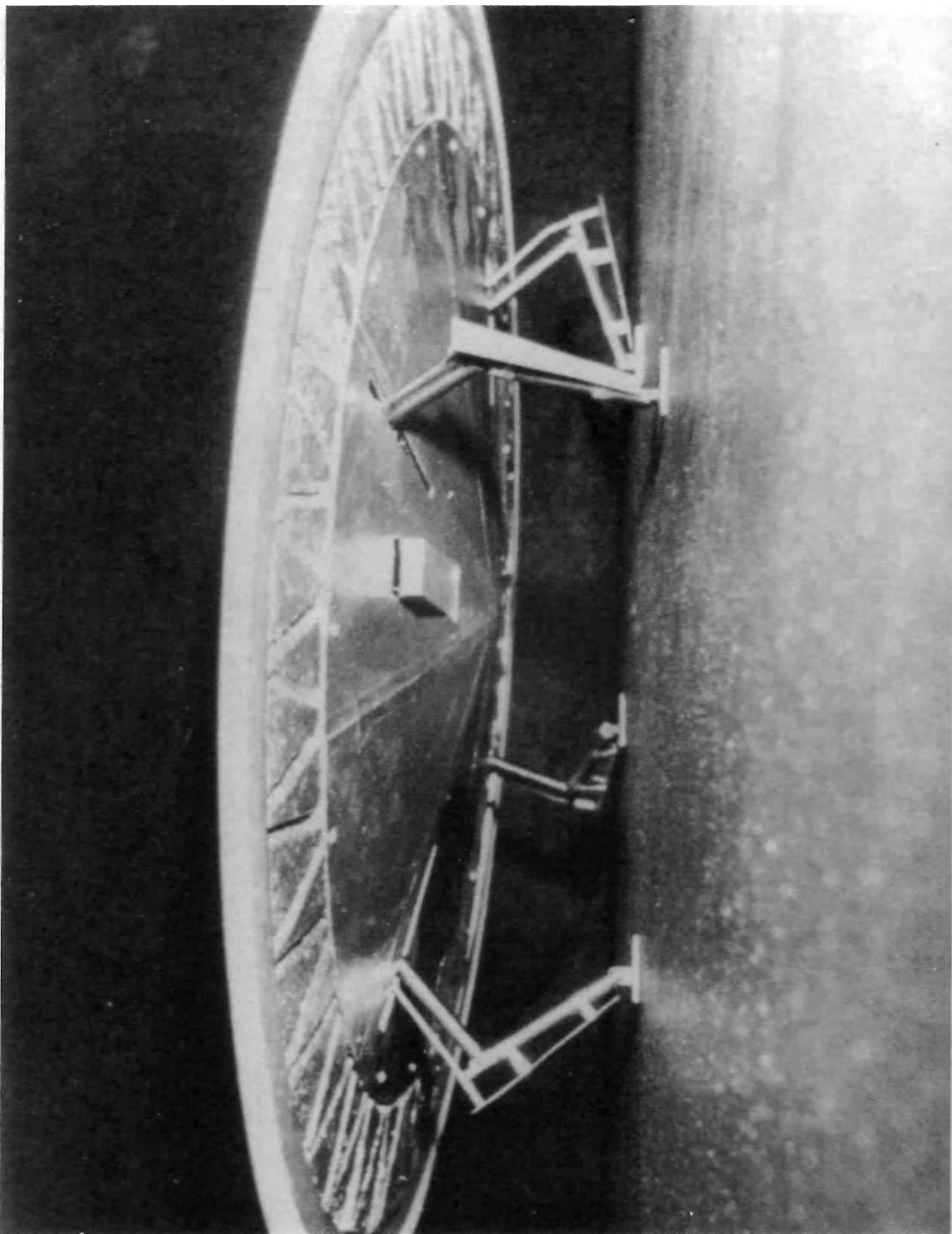
*Photo 21*





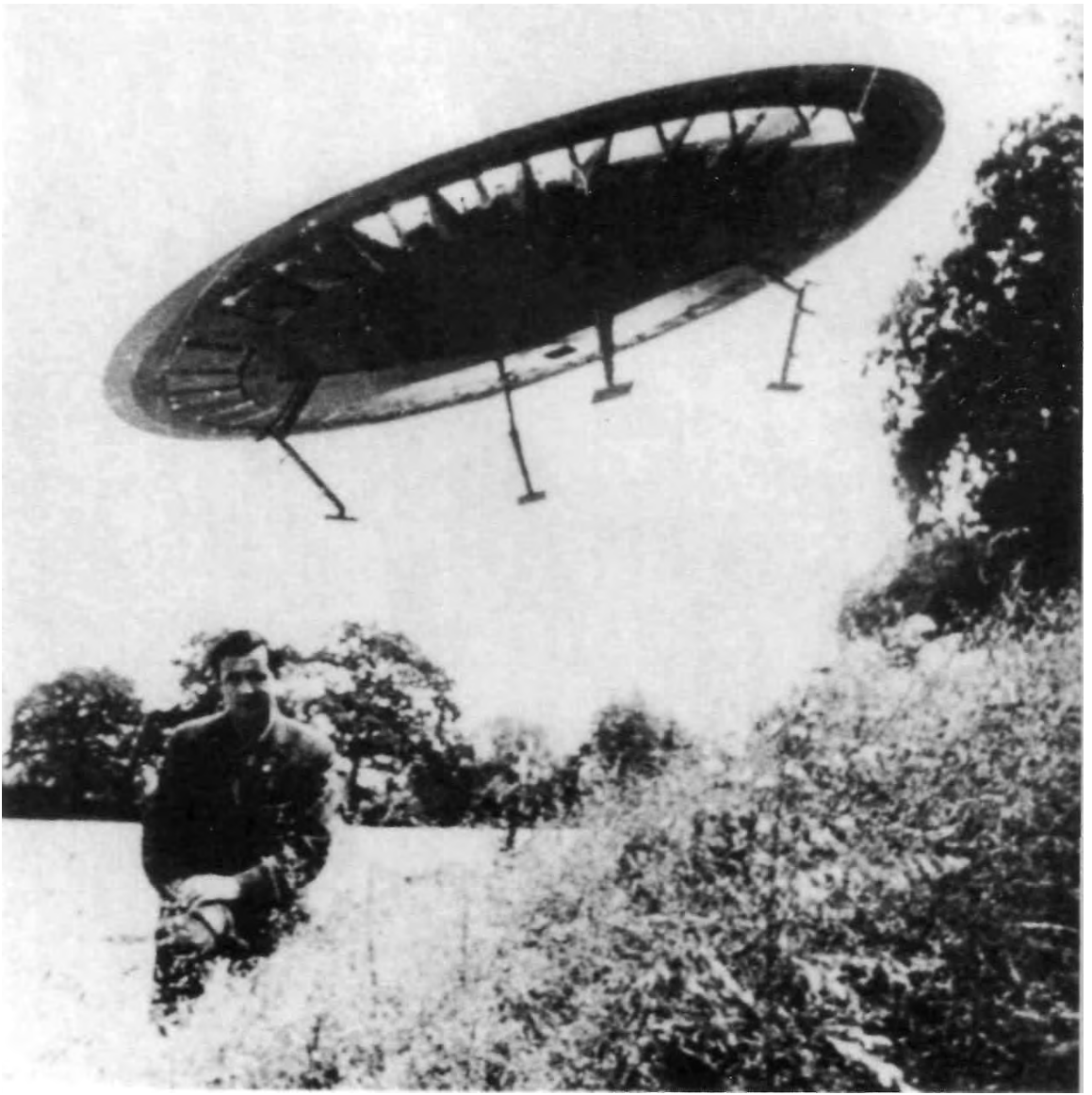


*Photo 23*





*Photo 25*



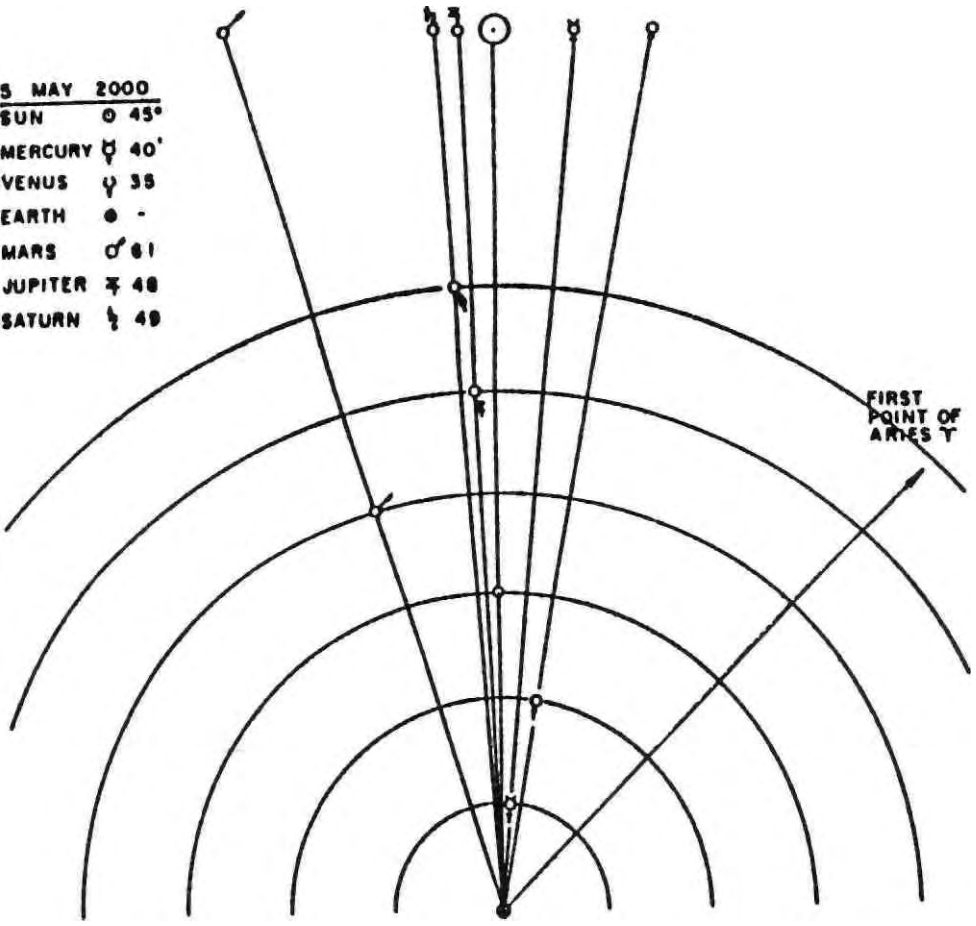


*Photo 27*

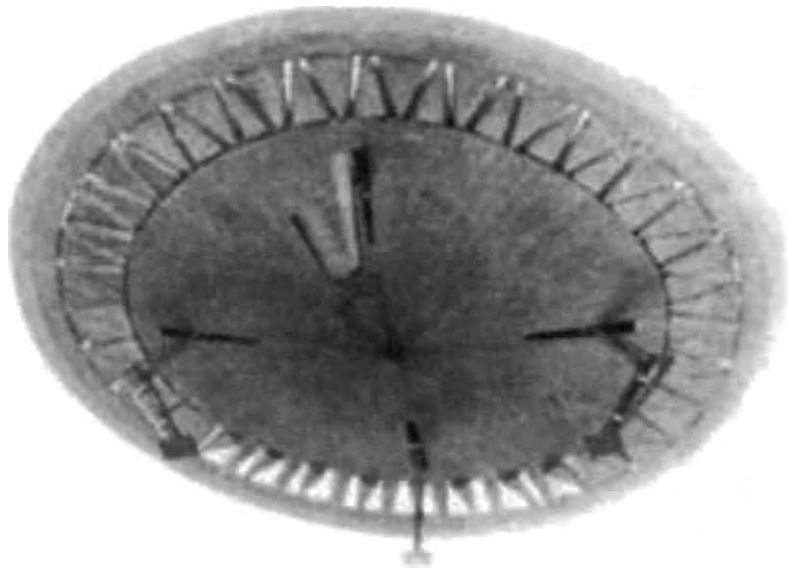


*Photo 28*

5 MAY 2000	
SUN	♁ 45°
MERCURY	♿ 40°
VENUS	♀ 35
EARTH	♁ -
MARS	♂ 81
JUPITER	♃ 48
SATURN	♄ 49



*The Position of the Planets on 5 May 2000.*



# THE SECRET TECHNOLOGY OF JOHN R. R. SEARL

## THE LAW OF THE SQUARES:

BOOKS 1,1A, 1B, 2, 6,7,7A, 7B, 8, 8A, 8B.....\$50.00  
EACH

BOOKS 3,4,5.....\$60.00  
EACH

ALSO AVAILABLE:

VIDEO OF 1989 MUNICH LECTURE BY PROF. J.R.R. SEARL \$50.00



JOHN A. THOMAS JR, 373 ROCK BEACH ROAD, ROCHESTER, NEW YORK, 14617-1316